

Nimi/Name	Poppy 179x119_16		
Joonis/Zeichnung/Drawing	3D		
Profiil/Profil/Profile	1.6x11.3	Kuupäev/Datum/Date	03.05.2018

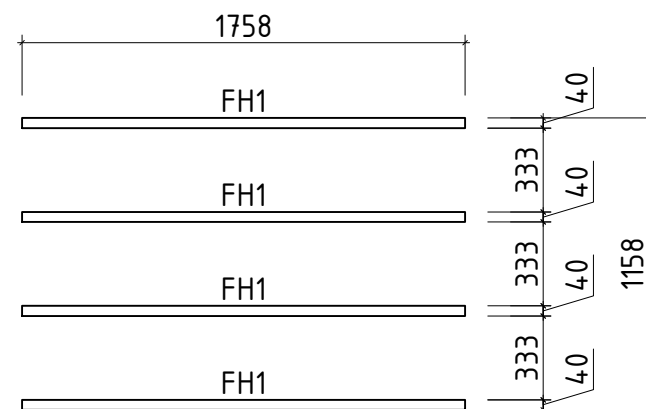
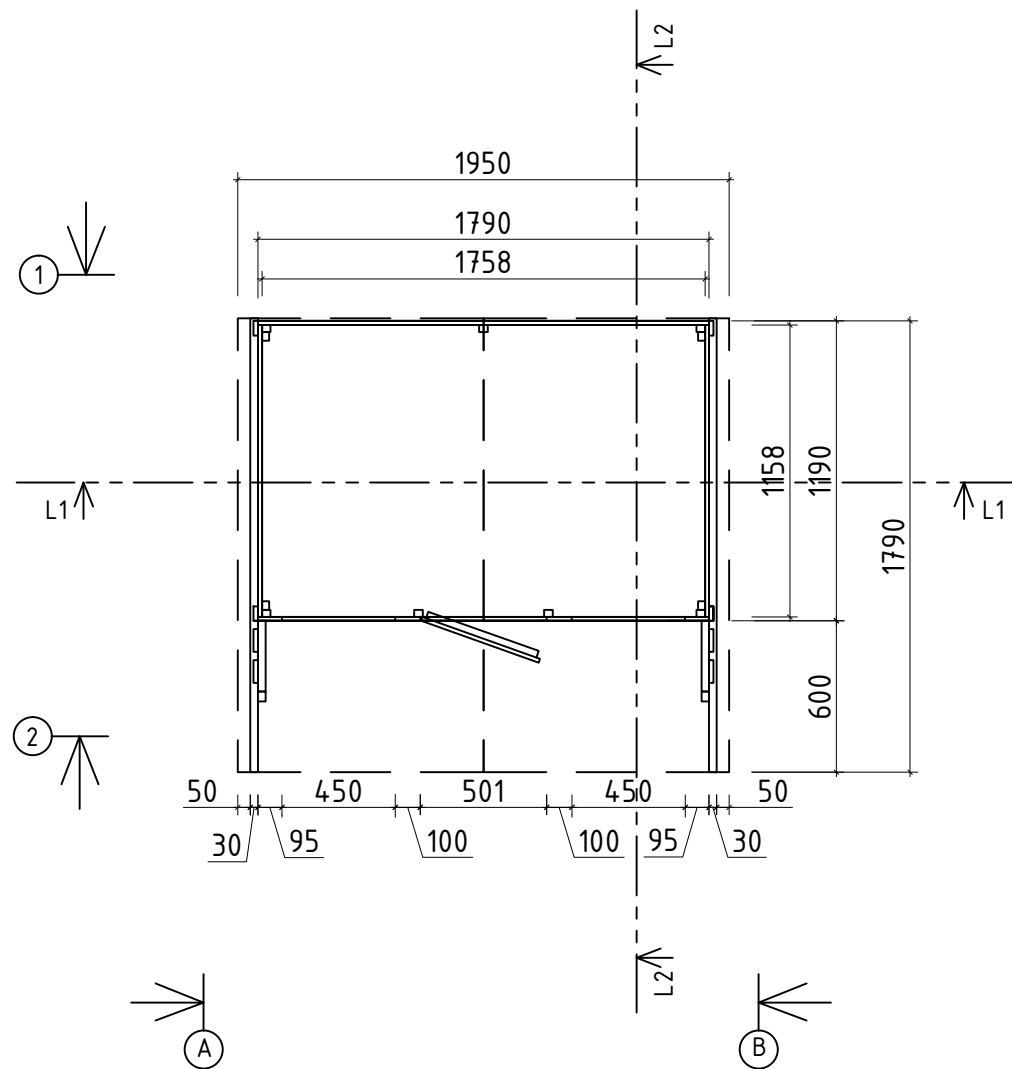

Alustalade plaan / Lagerholzplan / Foundation beams

Nimi/Name	Poppy 179x119_16	
Joonis/Zeichnung/Drawing	Põhiplaan_Grundplan_Plan	
Profil/Profil/Profile	1.6x11.3	Kuupäev/Datum/Date 03.05.2018

Sein / Wand / Wall 1

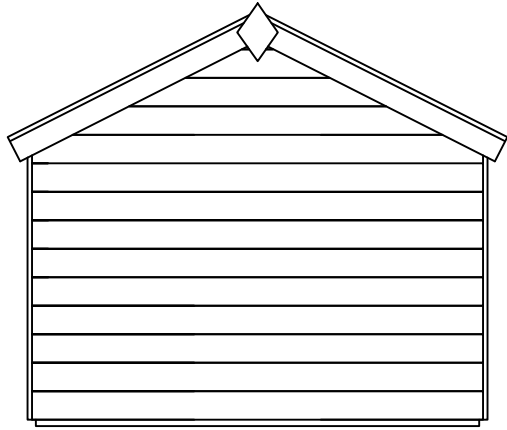

Sein / Wand / Wall 2

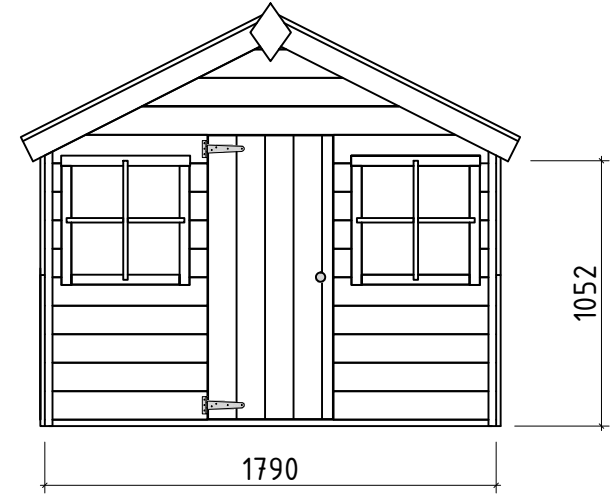

Sein / Wand / Wall A

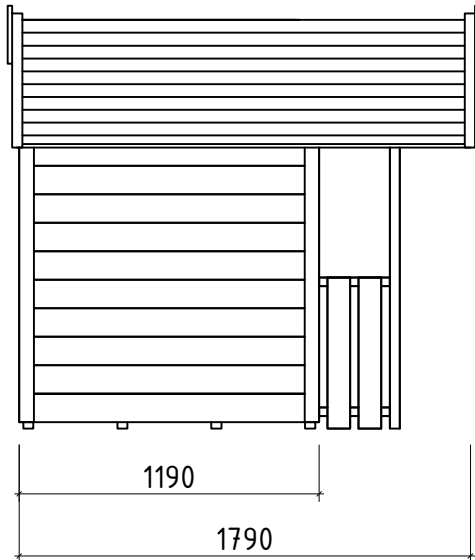

Sein / Wand / Wall B

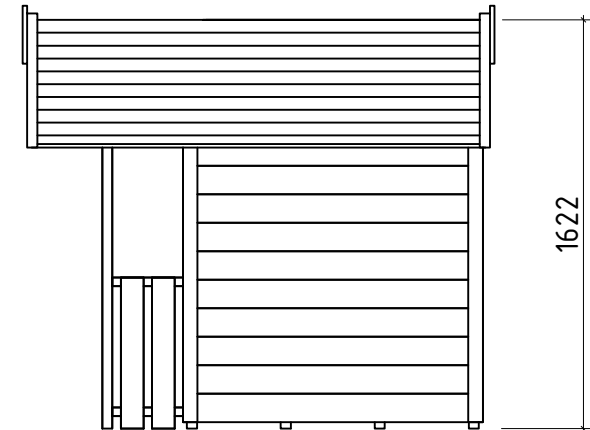

Nimi/Name	Poppy 179x119_16		
Joonis/Zeichnung/Drawing	SEIN/WAND/WALL		
Profiil/Profil/Profile	1.6x11.3	Kuupäev/Datum/Date	03.05.2018



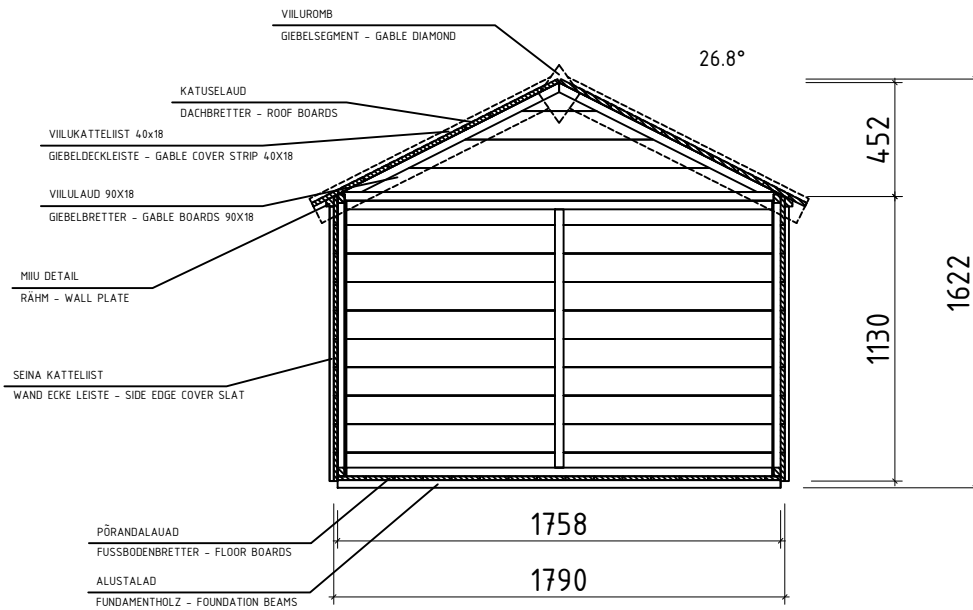

L1-L1

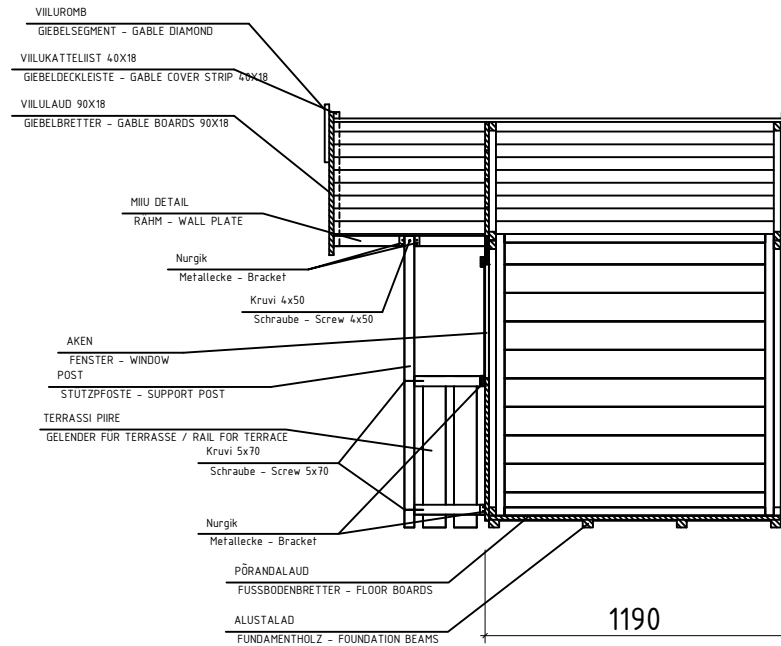

L2-L2

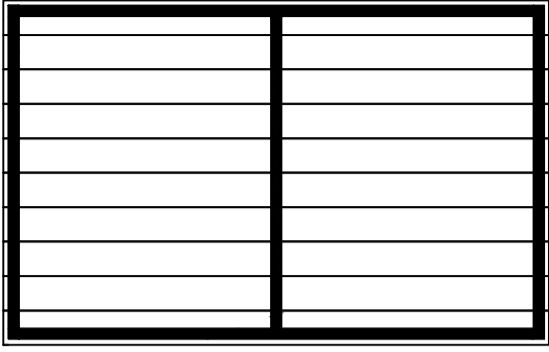
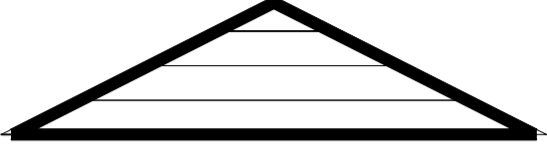
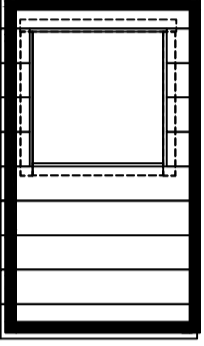
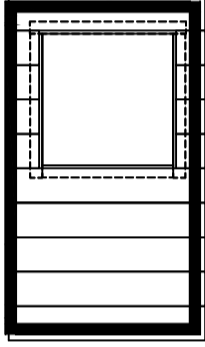
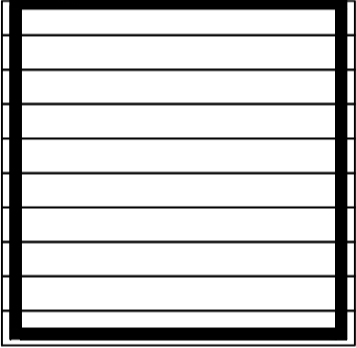
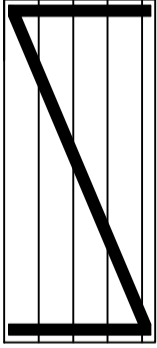
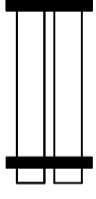

Nimi/Name	Poppy 179x119_16		
Joonis/Zeichnung/Drawing	Lõige/Schnitt/Section		
Profil/Profil/Profile	1.6x11.3	Kuupäev/Datum/Date	03.05.2018

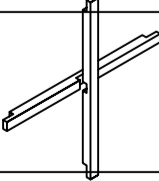
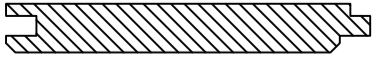
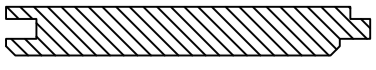
Pos	Spetsifikatsioon/Teieliste/Specification Poppy 179x119_16	Tk. Stck. Pcs.	Profiil Profile (mm)	Pikkus Length (mm)			
EL1	Sein / Wand / Wall 1 	1	1790x1130				
EL2	Sein / Wand / Wall 1 Sein / Wand / Wall 2 	2	1790x452				
EL3	Sein / Wand / Wall 2 aknaga / mit Fenster / with Window 	1	645x1130				
EL4	Sein / Wand / Wall 2 aknaga / mit Fenster / with Window 	1	645x1130				
EL5	Sein / Wand / Wall 3 Sein / Wand / Wall 4 	2	1158x1130				
EL6	Uks / Tür / Door 495x1125 	1	495x1125				
EL7	Terrassi piire Gelender für Terrasse / Rail for Terrace 	2	280x600				
FH1	ALUSTALAD (immutatud) - FUNDAMENTHOLZ (imprägniert) - FOUNDATION BEAM (impregnated) 	4	40x30	1758			
LE5	Seina katteliist - Wand ecke leiste - Side edge cover slat 	4	58x18	1090			
LE3	Post - Stützpfole - Support post 	2	40x30	1156			
LE1	Miuu detail - Rähm - Wallplate 	2	30x40	1800			
	Prossid - Sprossen - Muntins 	2+2	18x18	470			
	KATUSELAUD - DACHBRETTER - ROOF BOARDS  ✓	20+1	113x16	1800			
	PÕRANDALAUD - FUSSBODENBRETTER - FLOOR BOARDS  ✓	16+1	113x16	1158			
Kood	Poppy 179x119_16	Materjal	1.6x11.3	File	Poppy 179x119_16 KLIENT.dwg	geht	1/2

Poppy 179x119_16

1.

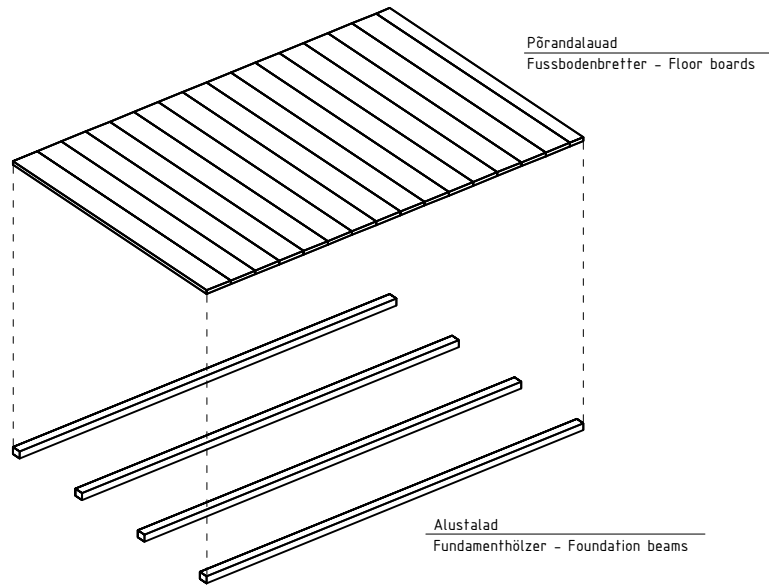

2.

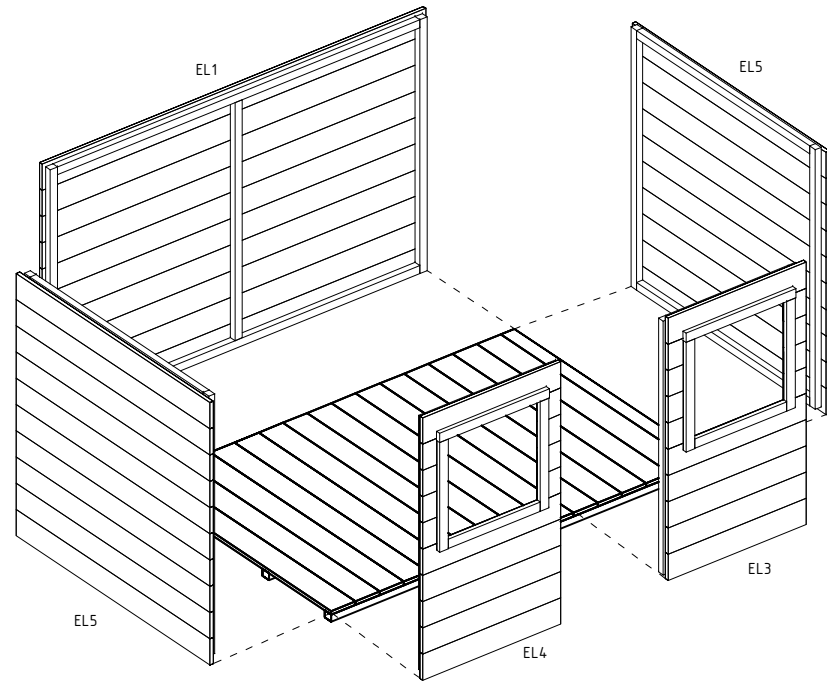

3.

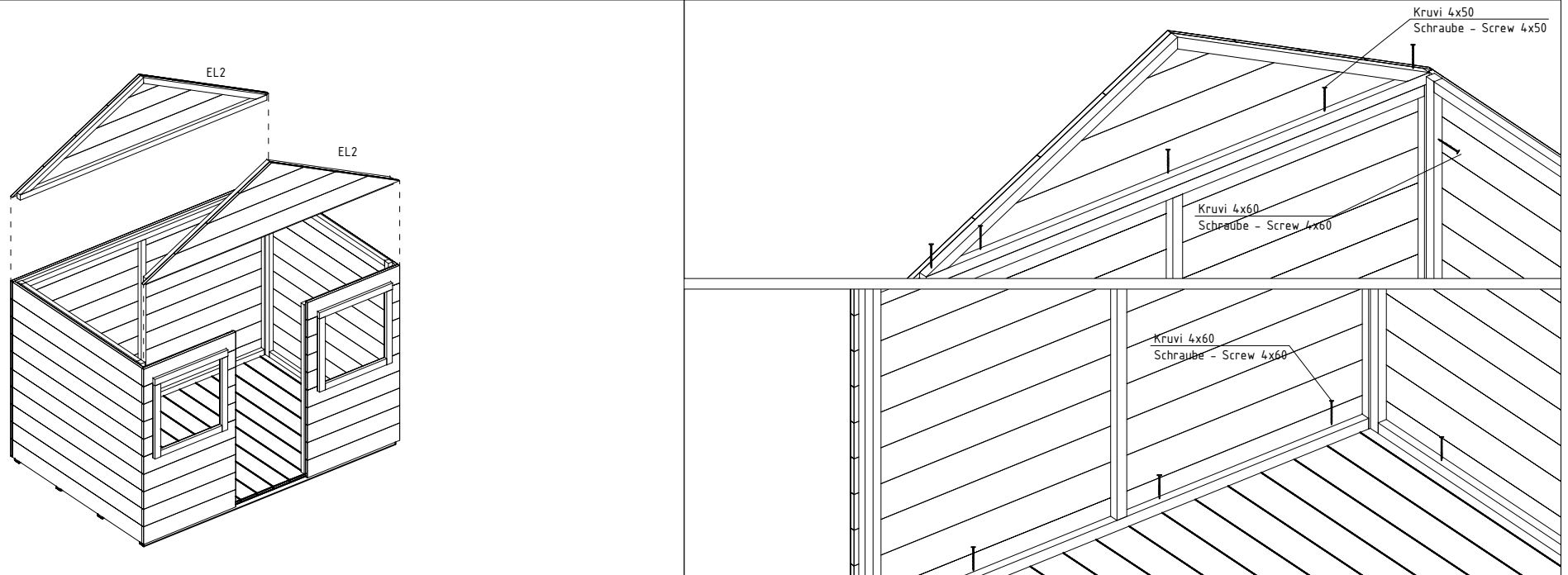

Poppy 179x119x16

4.

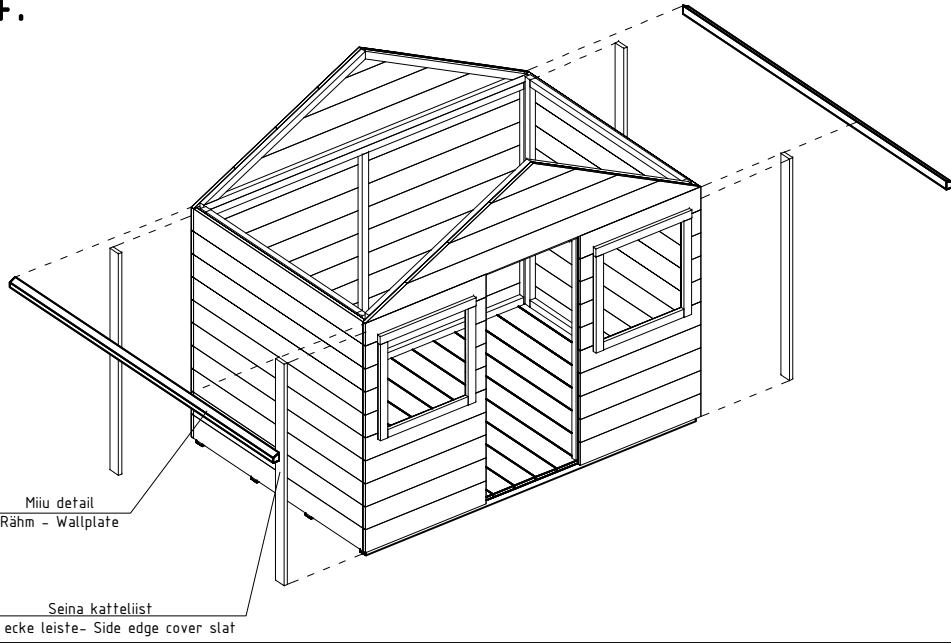

5.

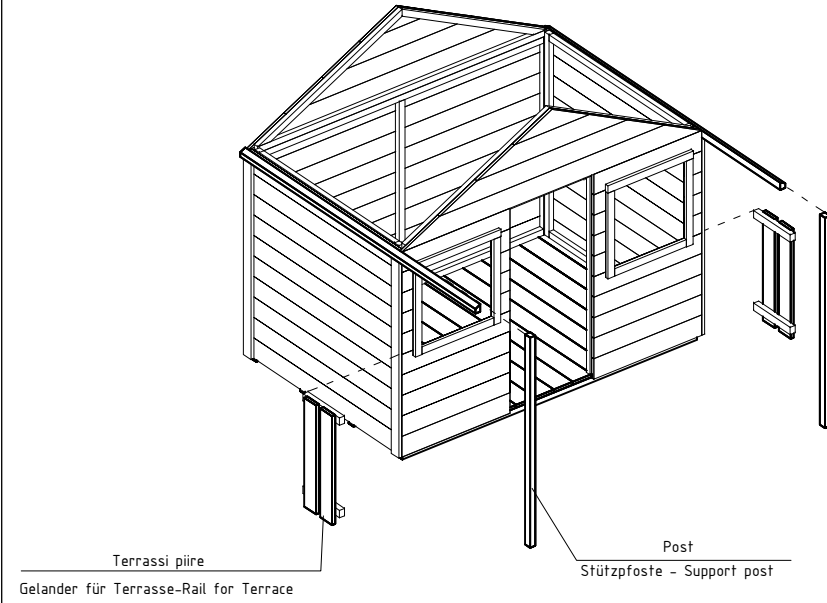

6.

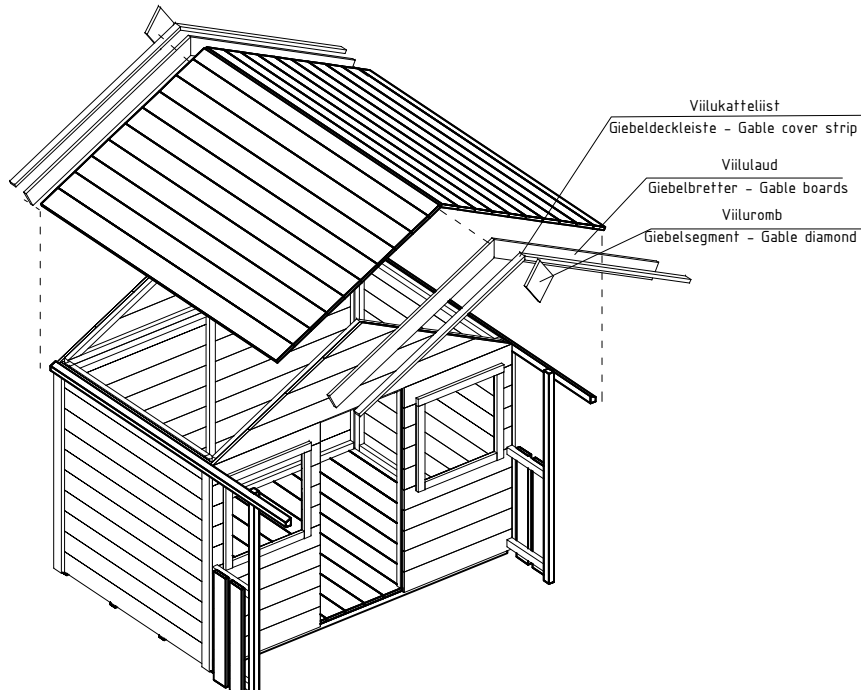

7.

