

Tessa 220x180 16

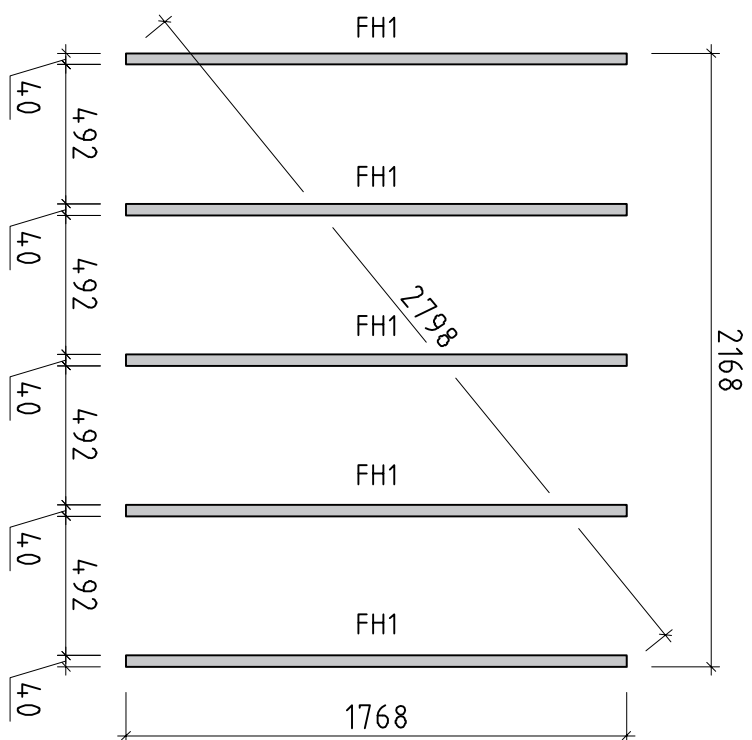
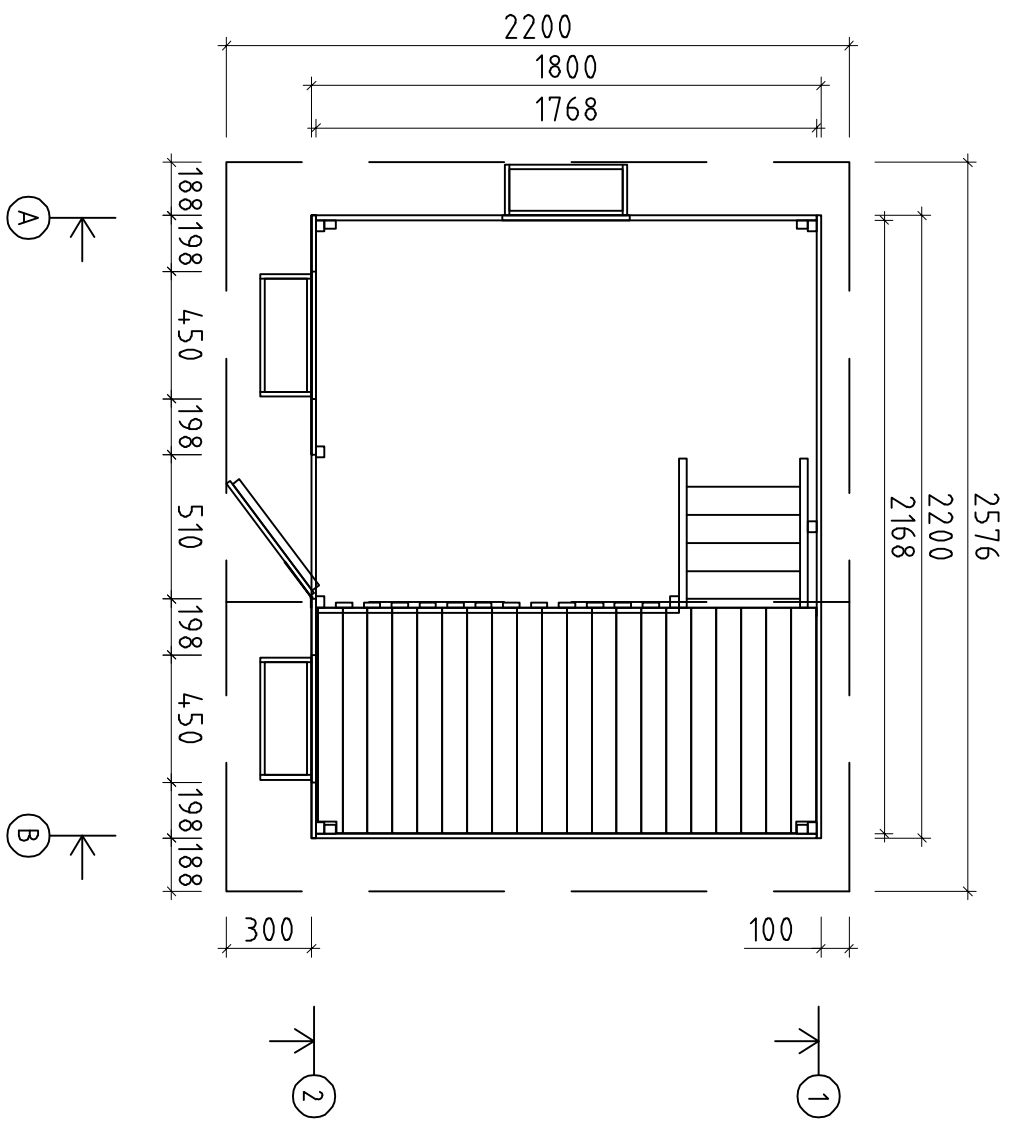

Tessa 220x180 16

Põhiplaan/Grundplan/Plan

Sein/Wand/Wall 1

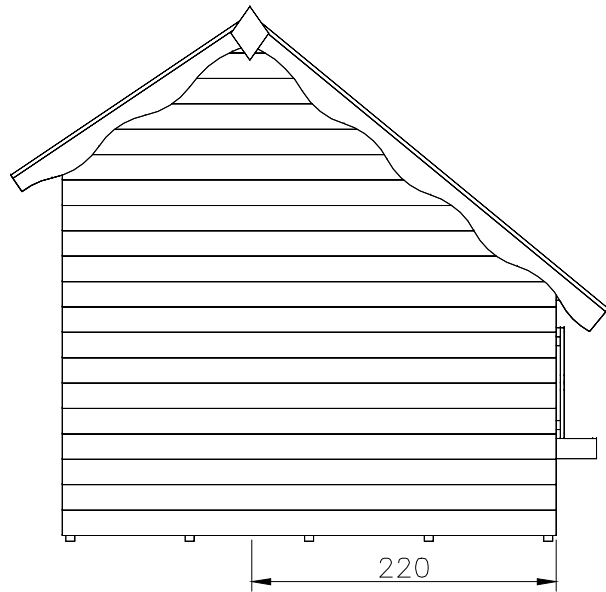

Sein/Wand/Wall 2



Sein/Wand/Wall A

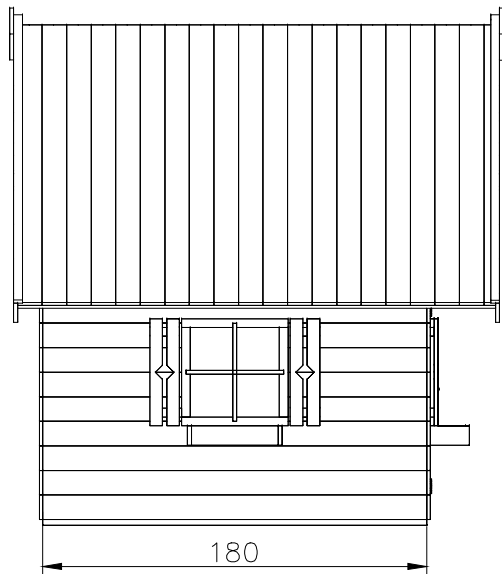

Sein/Wand/Wall B

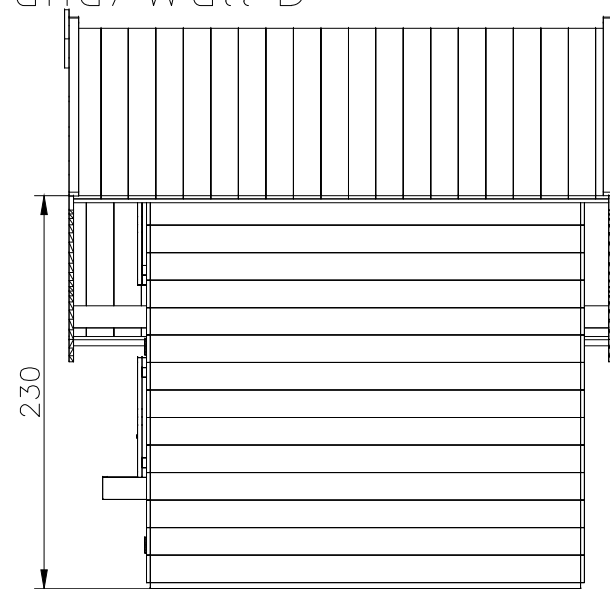



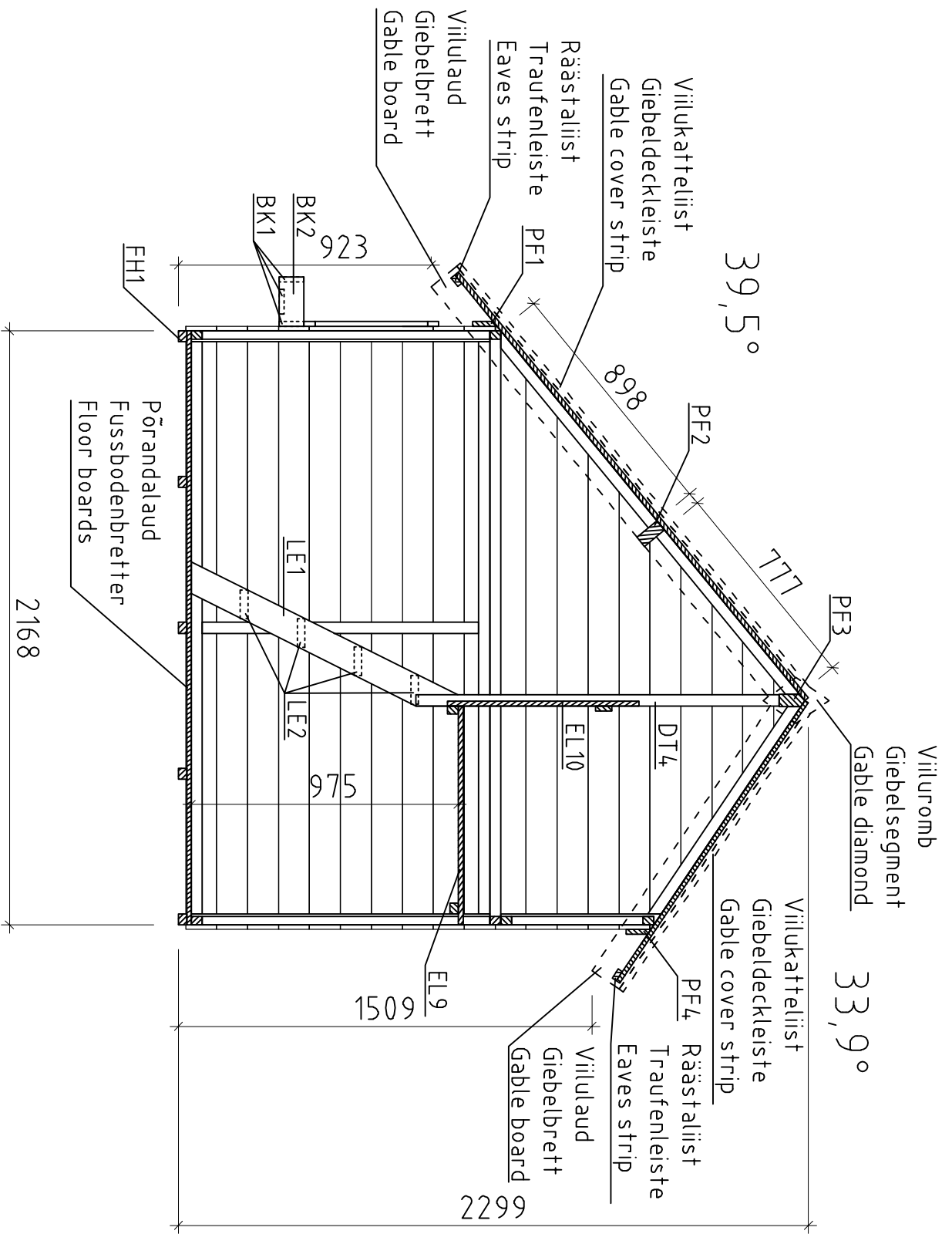





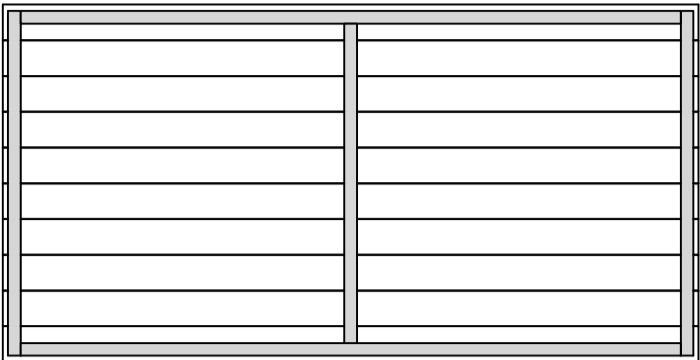
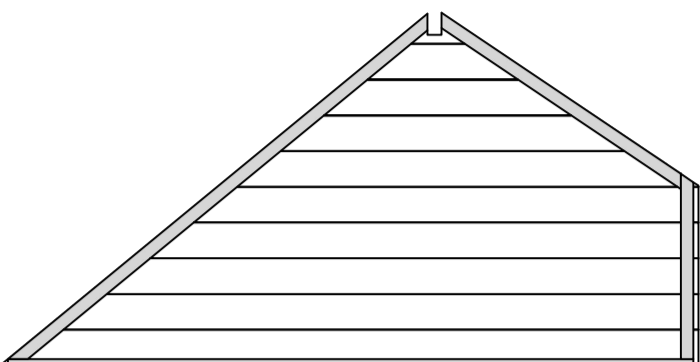
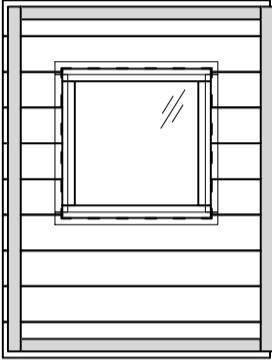
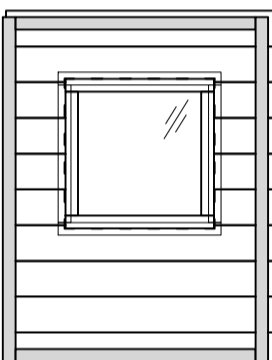
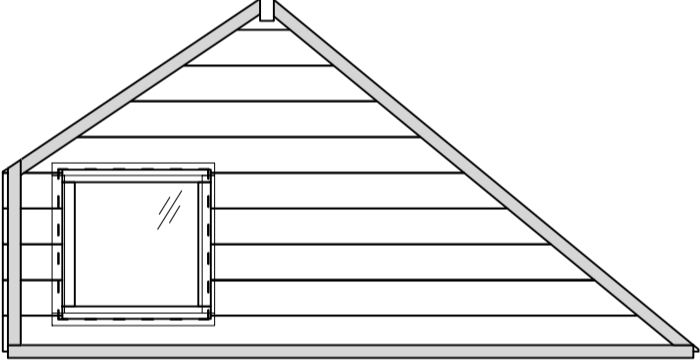
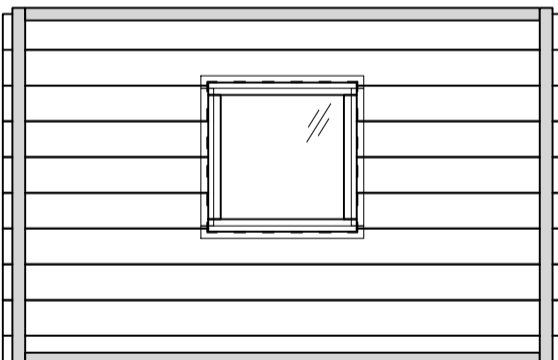
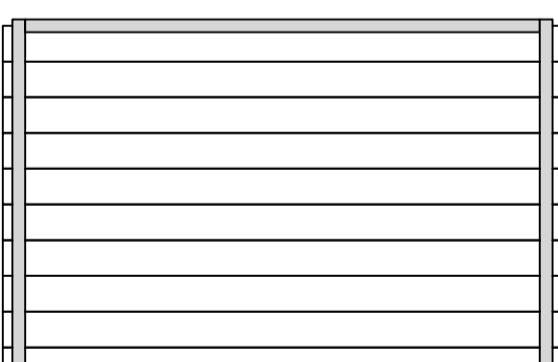

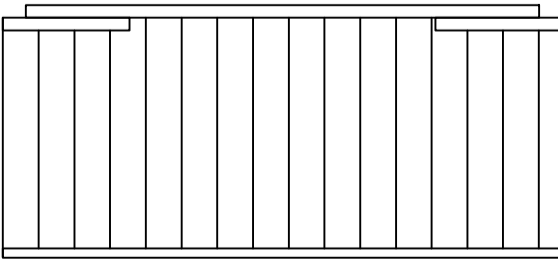

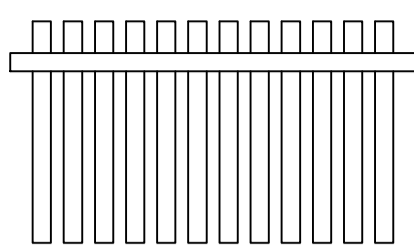
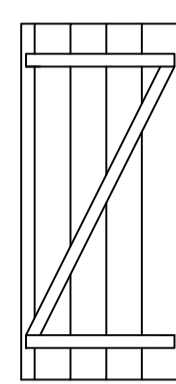
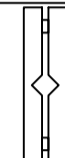

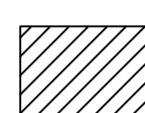

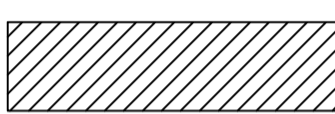

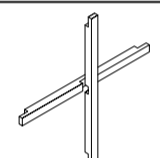





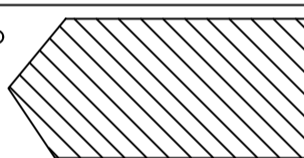

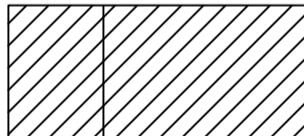

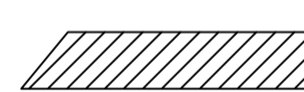
Tessa 220x180 16

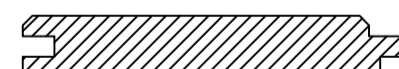

Tõssa 220x180 16

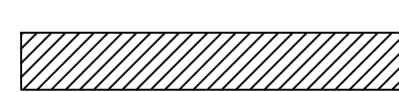
Lõige/Schnitt/Section

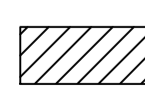
Pos	Spetsifikatsioon/Teileliste/Specification Tessa 220x180 16	tk. Stck Pcs.	Pfoiil/Profil Profile (mm)	Pikkus/ Länge/ Length (mm)		
EL1	Sein/Wand/Wall 1 	1	2200x1130			
EL2	Sein/Wand/Wall 1 	1	2200x1135			
EL3	Sein/Wand/Wall 2 aknaga/mit Fenster/with window 	1	855x1130			
EL4	Sein/Wand/Wall 2 aknaga/mit Fenster/with window 	1	855x1130			
EL5	Sein/Wand/Wall 2 aknaga/mit Fenster/with window 	1	2200x1135			
EL6	Sein/Wand/Wall A aknaga/mit Fenster/with window 	1	1768x1150			
EL7	Sein/Wand/Wall B 	1	1768x1150			
EL8	Sein/Wand/Wall B 	1	1768x579			
EL9	Rõdu põrand/Balkon bodent/ Balcony floor 	1	1768x799			
Kood	Tessa 220x180 16	Materjal	File	Tessa 220x180 16.dwg	Leht	1/3

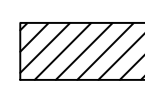
Pos	Spetsifikatsioon/Teileliste/Specification Tessa 220x180 16		tk. Stck Pcs.	Pfoiil/Profil Profile (mm)	Pikkus/ Länge/ Length (mm)	
	EL 10	Rõdu piire/Geländer/Railing		1	1282x700	
	EL 11	UKS/TÜR/DOOR 500x1125		1	500x1125	
	EL 12	Akna luugid/Klappläden/Shutters		8	136x515	
FH1	ALUSTALAD (immutatud)/FUNDAMENTHÖLZER (imprägniert)/FOUNDATION BEAMS (impregnated)			5	40x30	1768
DT4		(redeli ja rõdupiirde post) (Stütze für die Treppe und der Handlauf) (support for the ladder and railing)		1	40x30	1326
LE1		(redeli küljelaud) (für die Leiter) (for the ladder)		2	28x95	1123
LE2		(redeli astmelaud) (für die Leiter) (for the ladder)		4	28x95	400
LE7		(prossid) (Sprossen) (muntins)		4+4	18x18	465
BK1		LILLEKASTID/BLUMENKÄSTEN/FLOWER BOXES		9	18x90	400
BK2		LILLEKASTID/BLUMENKÄSTEN/FLOWER BOXES		6	18x90	180
PF3		PÄRLIN/PFETTE/PURLIN		1	44x94	2200
PF2		PÄRLIN/PFETTE/PURLIN		1	44x94	1768
PF1		PÄRLIN/PFETTE/PURLIN		1	18x90	2200
PF4		PÄRLIN/PFETTE/PURLIN		1	18x90	2200
	Põrandalauad Fussbodenbretter Floor boards			16+1	113x16	2170
	Katuselauad Dachbretter Roof boards			20+1	113x16	2010
	Katuselauad Dachbretter Roof boards			20	113x16	1235
	Viilulauad Giebelzierbretter Gable trim boards	33,9°  33,9°	 ✓	1+1	120x18	1315
	Viilulauad Giebelzierbretter Gable trim boards	39,4°  39,4°	 ✓	1+1	120x18	2090
	Viilukatteliistud Giebeldeckleisten Gable cover strips		 ✓	2	40x18	1315
	Viilukatteliistud Giebeldeckleisten Gable cover strips		 ✓	2	40x18	2090
	Räästaliistud Traufenleisten Eaves strips			2	40x18	2200



1.

Põrandalaud  
Fussbodenbretter  
Floor boards

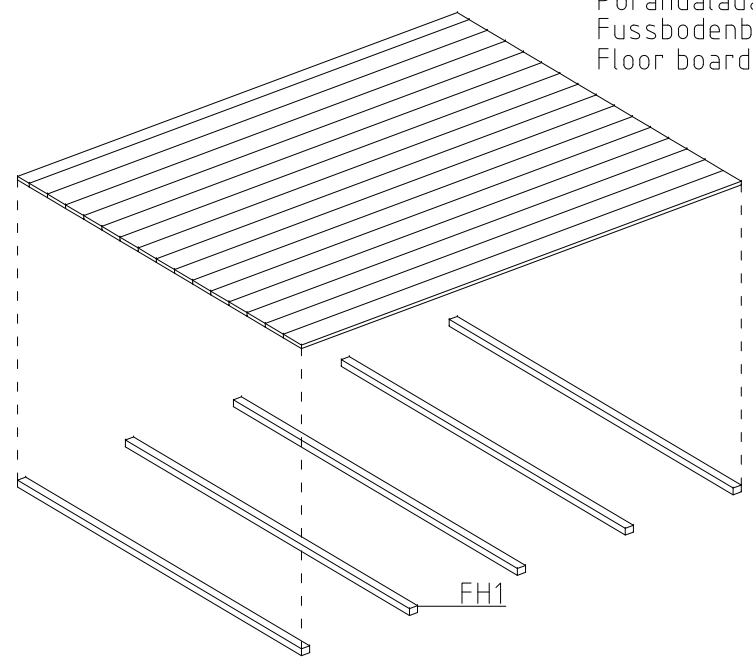

2.

Tessa 220x180 16

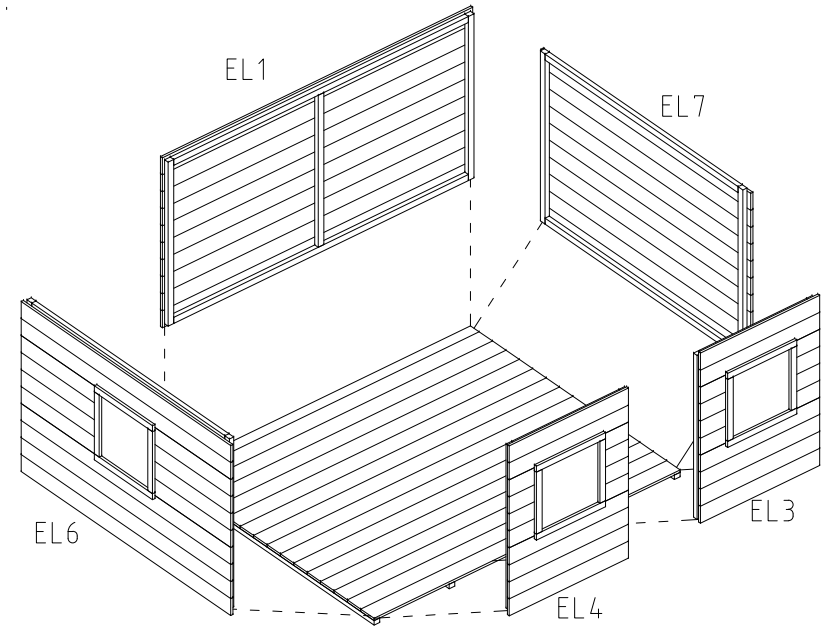

3.

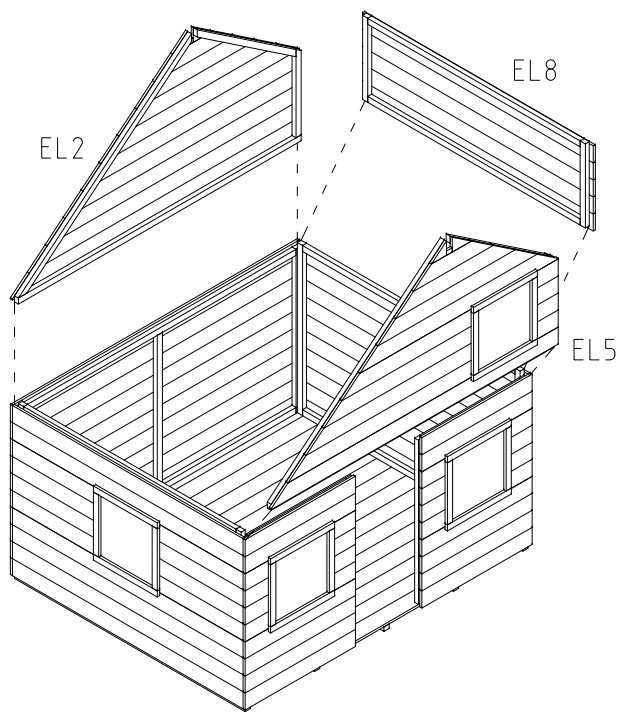

4.

Metallnurgik  
Winkel  
Brackets

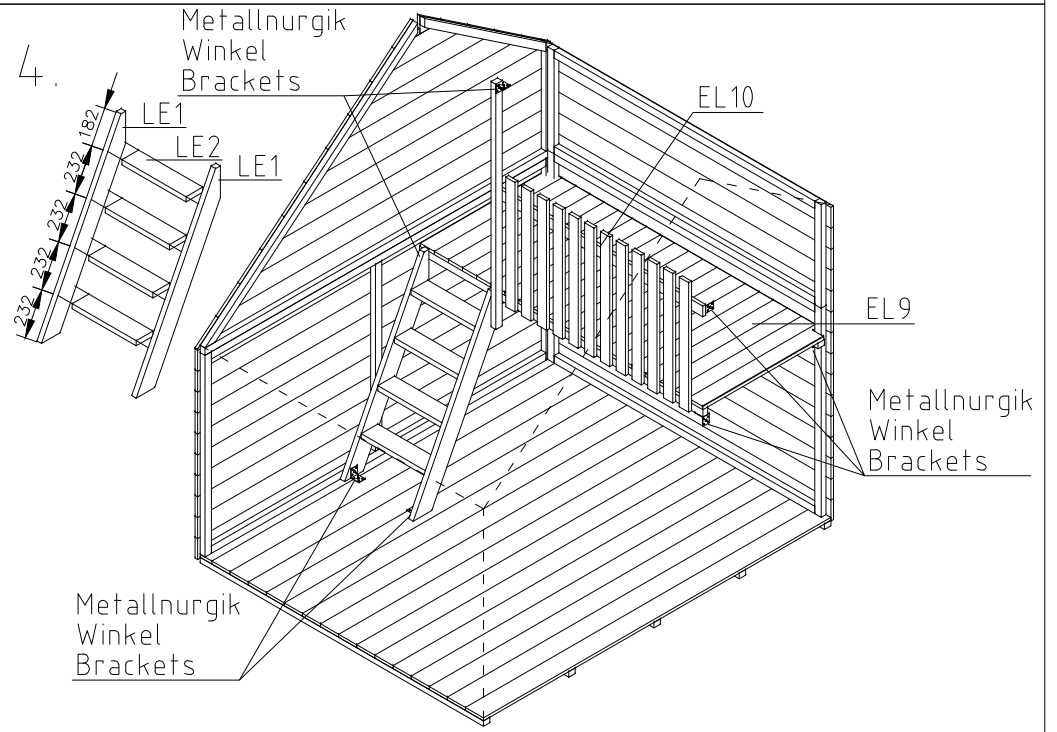

5.

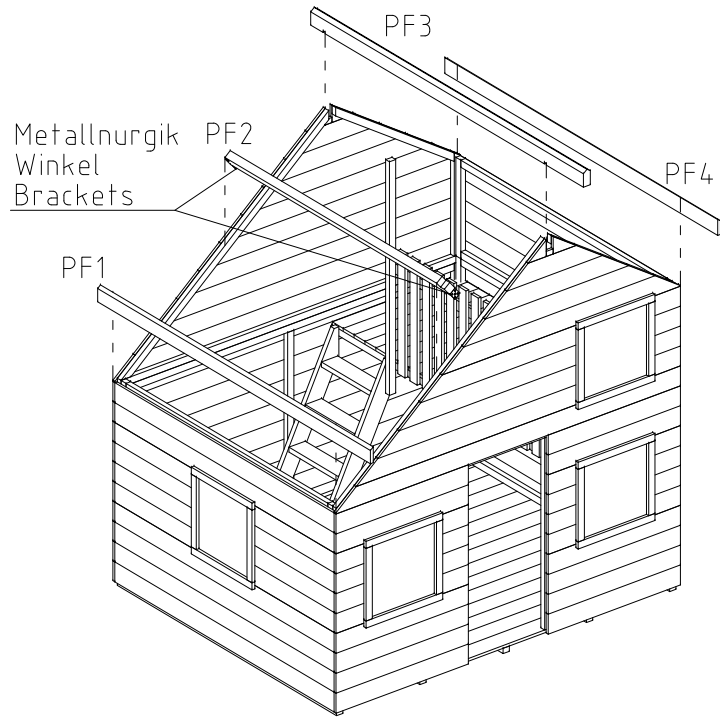

6.

### Tessa 220x180 16

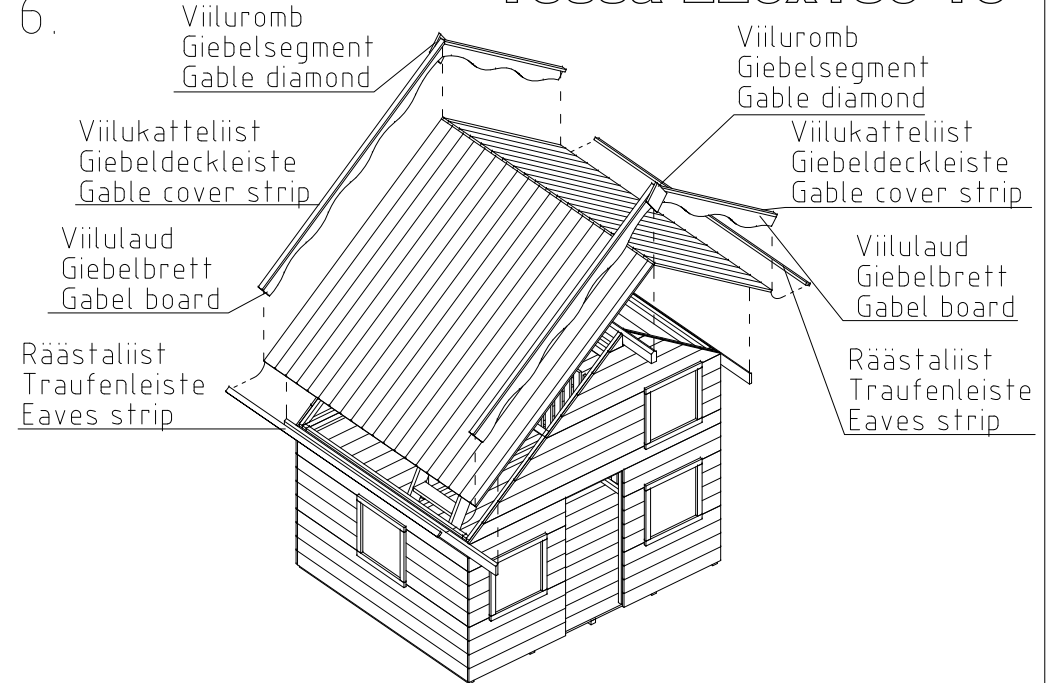

7.



8.

