

Argus 44 6x6

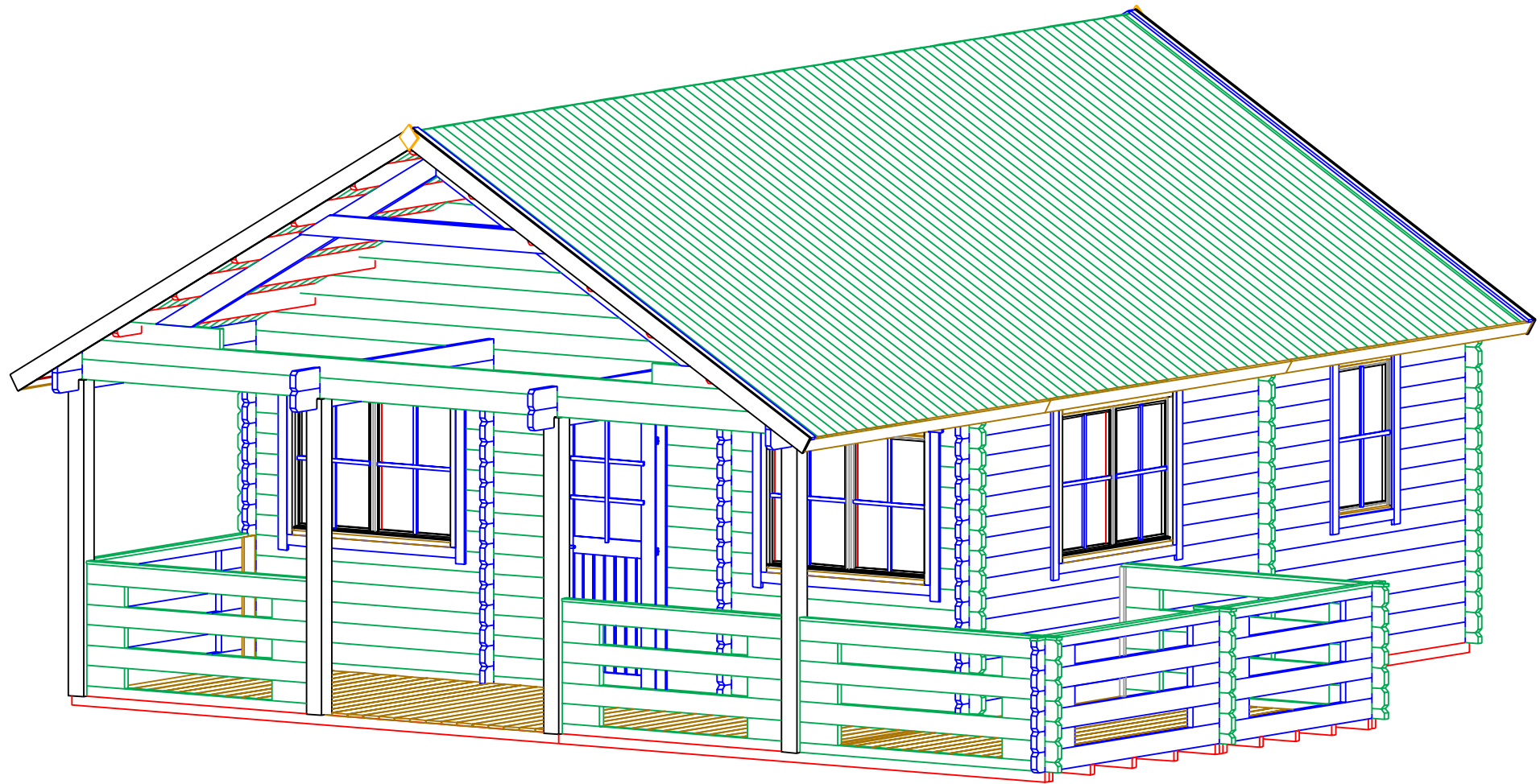

Argus 44 6x6

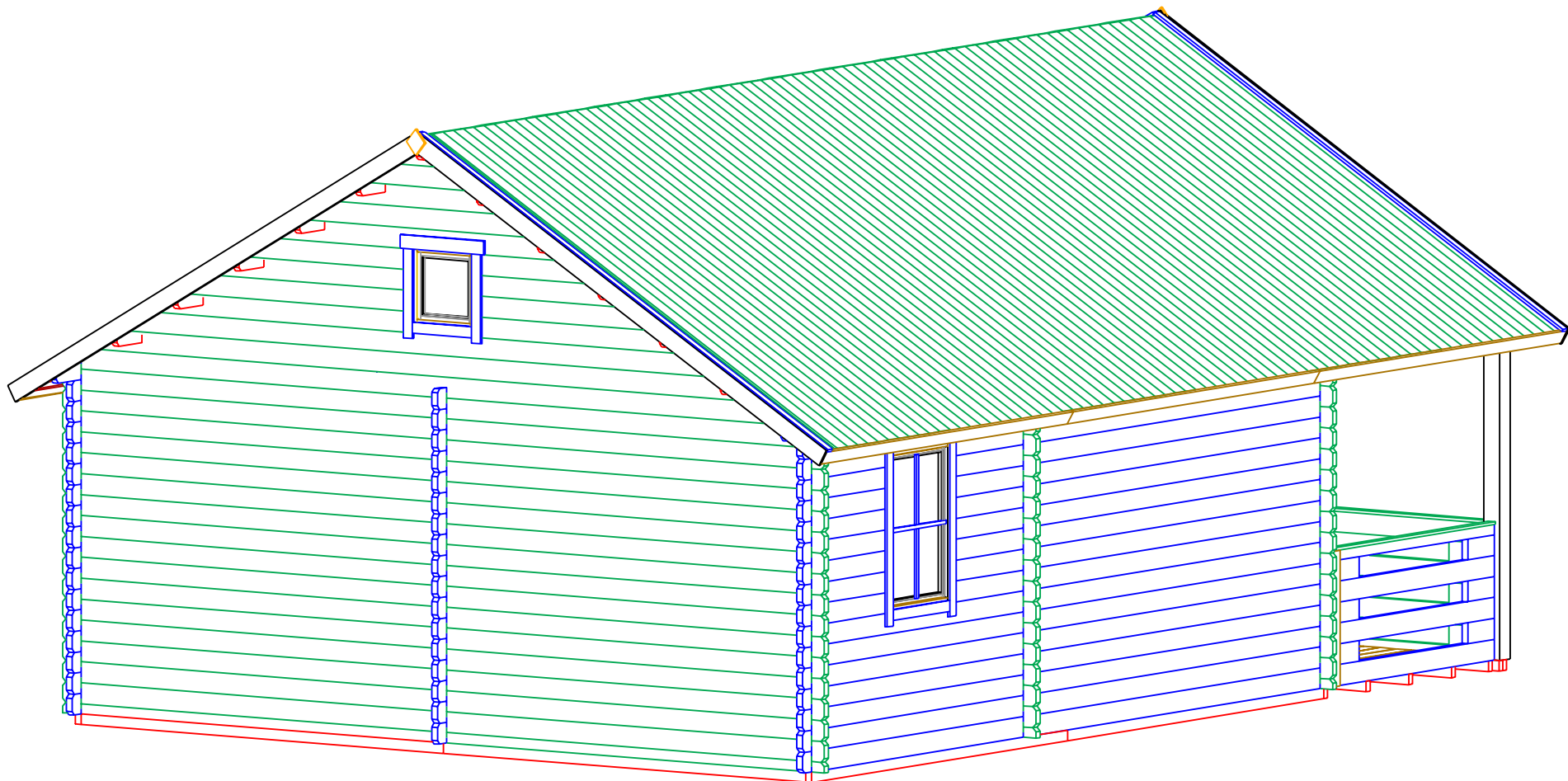

STAGE 1

Argus 44 6x6

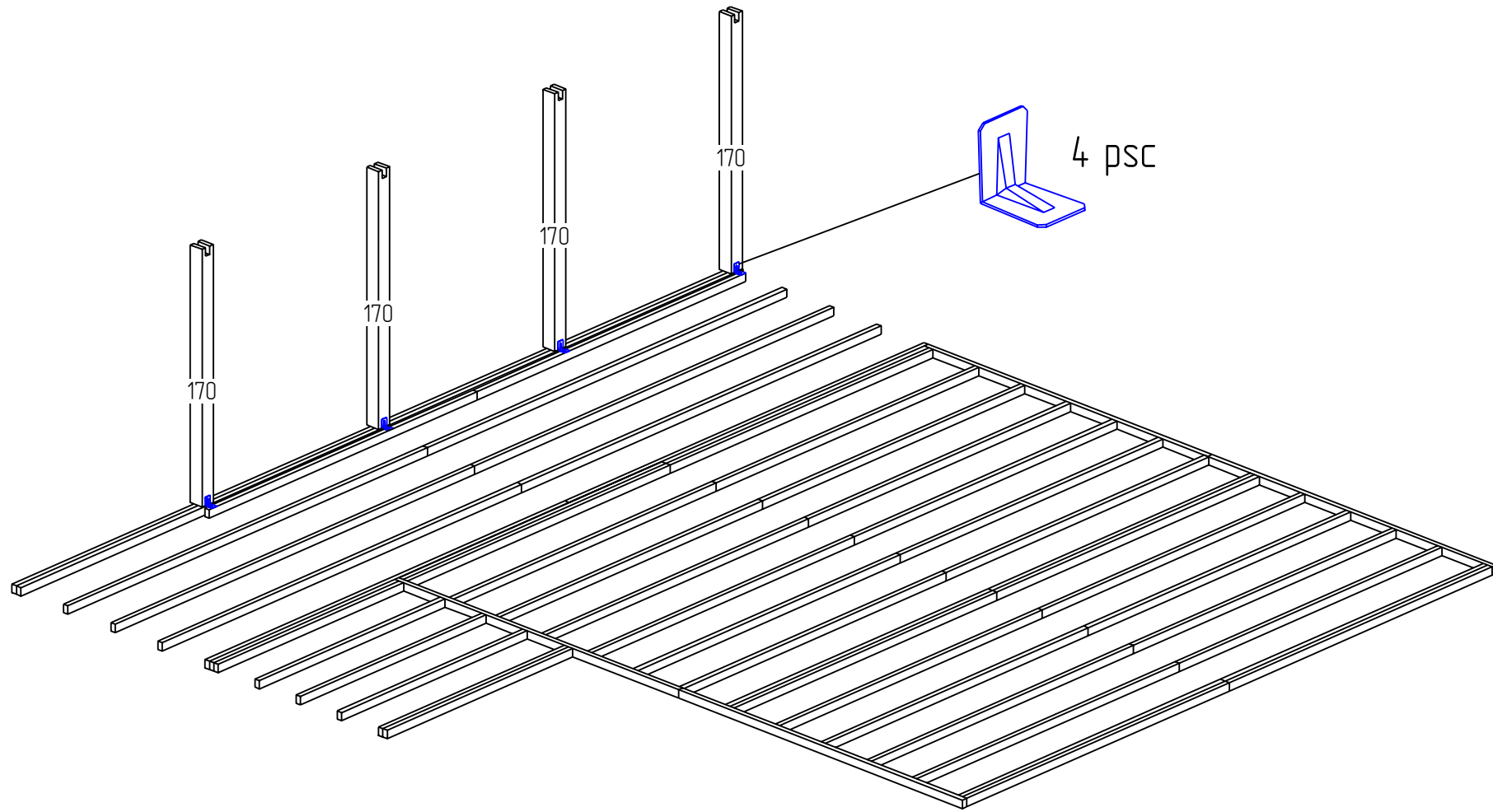

STAGE 2

Argus 44 6x6

W-A

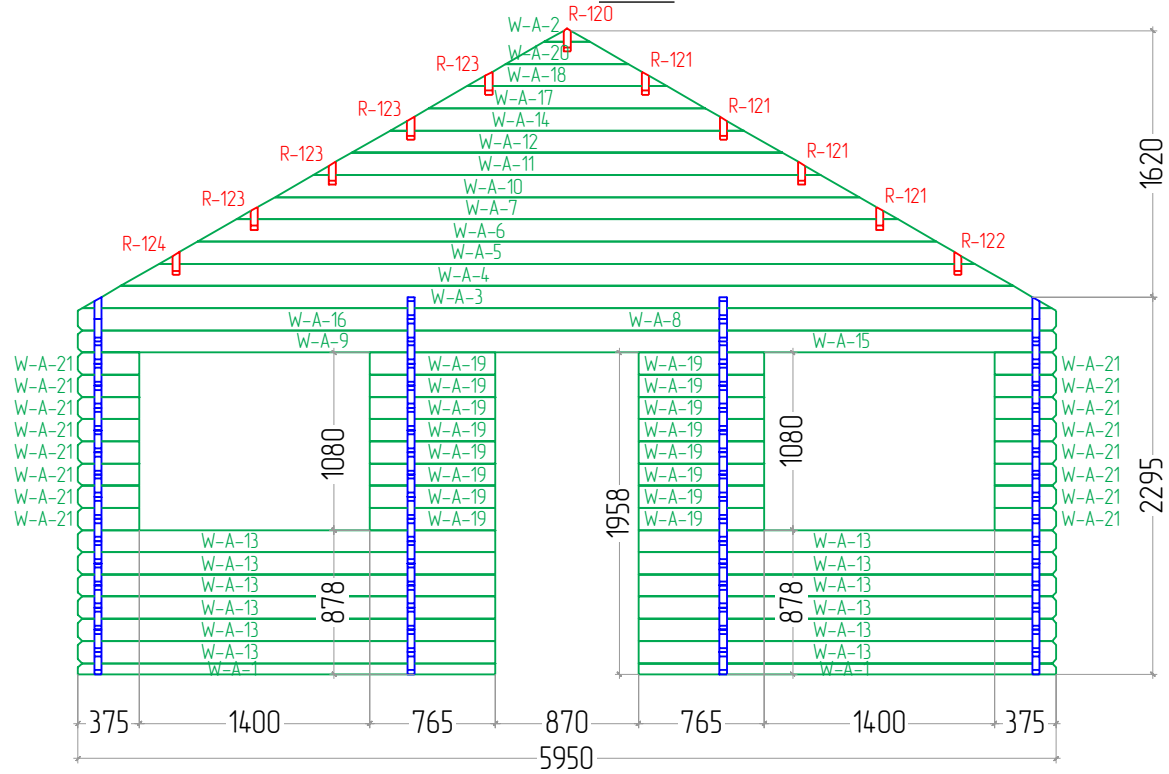

W-B

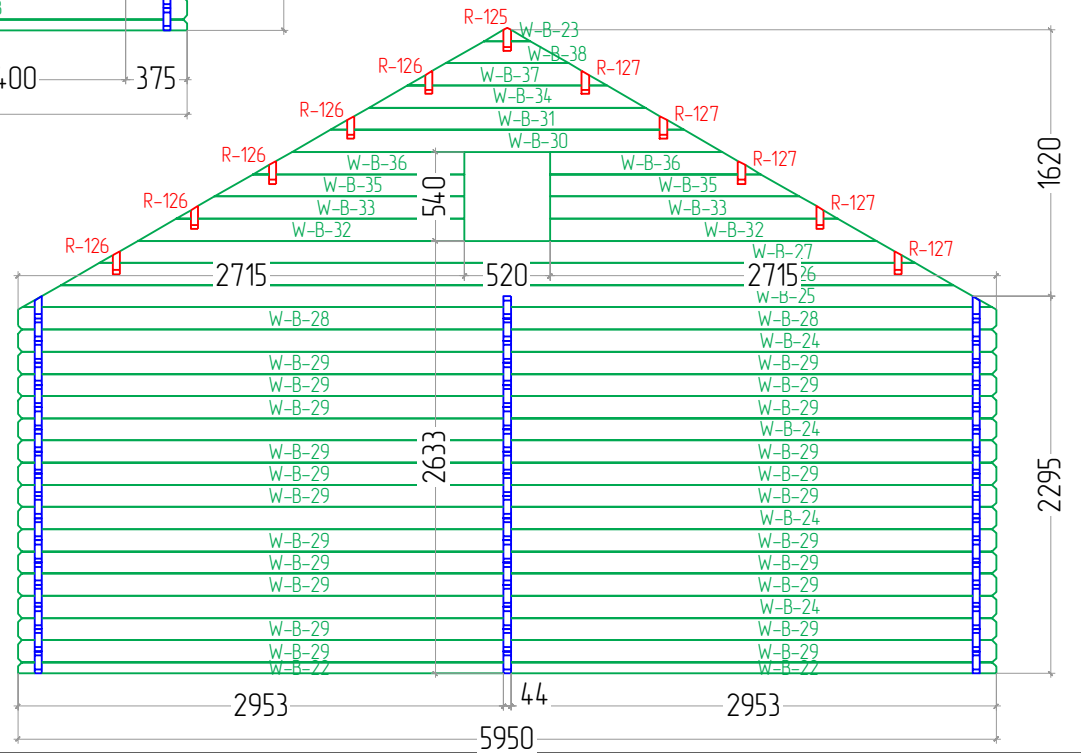

W-E

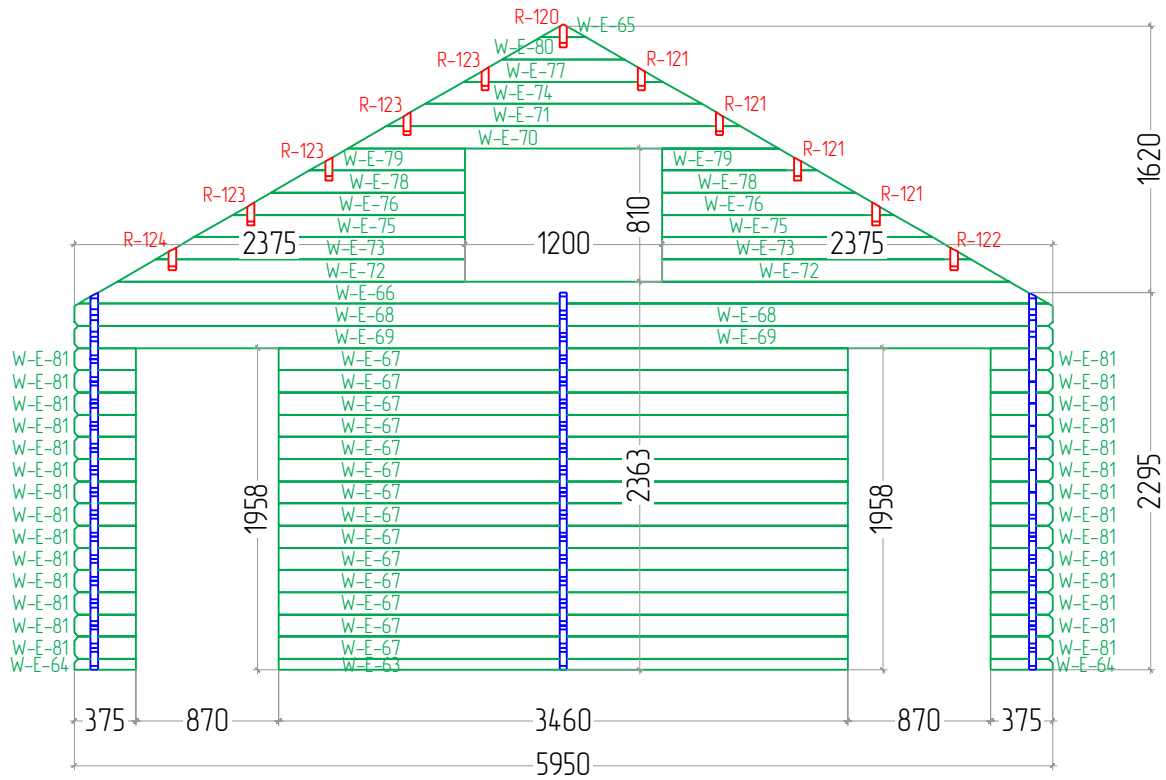

W-F

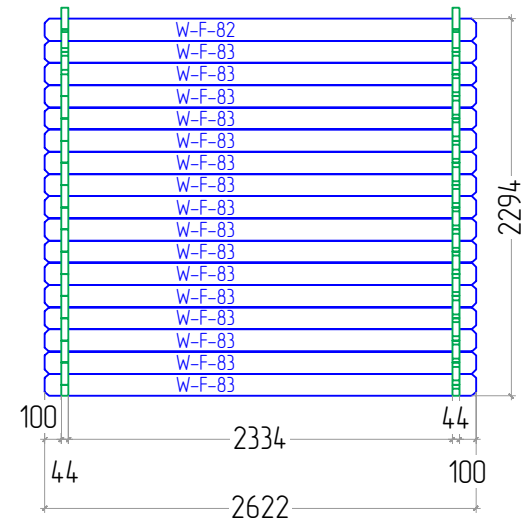

STAGE 2

Argus 44 6x6

W-I

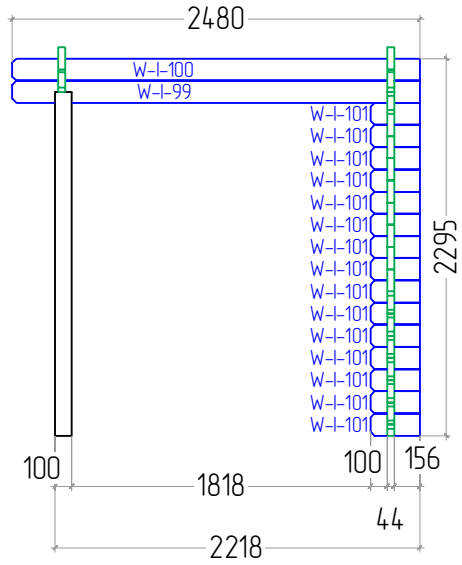

W-H

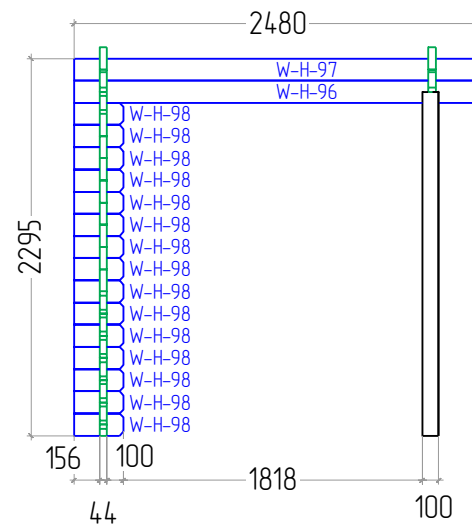

W-J

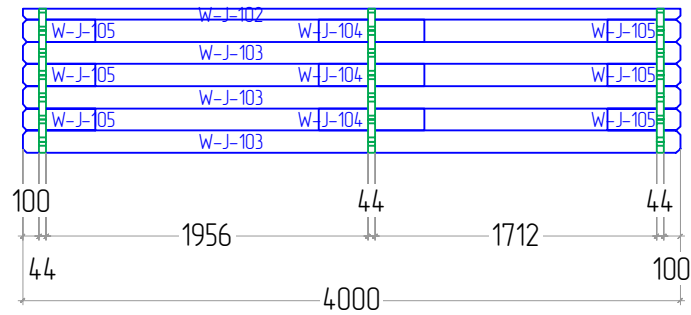

W-K

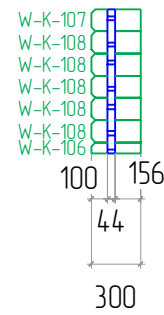

W-L

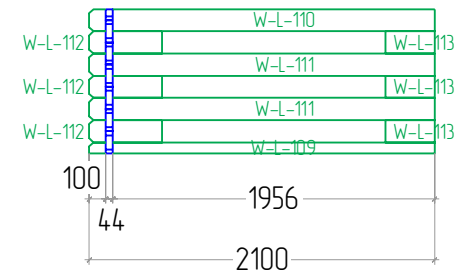

STAGE 2

Argus 44 6x6

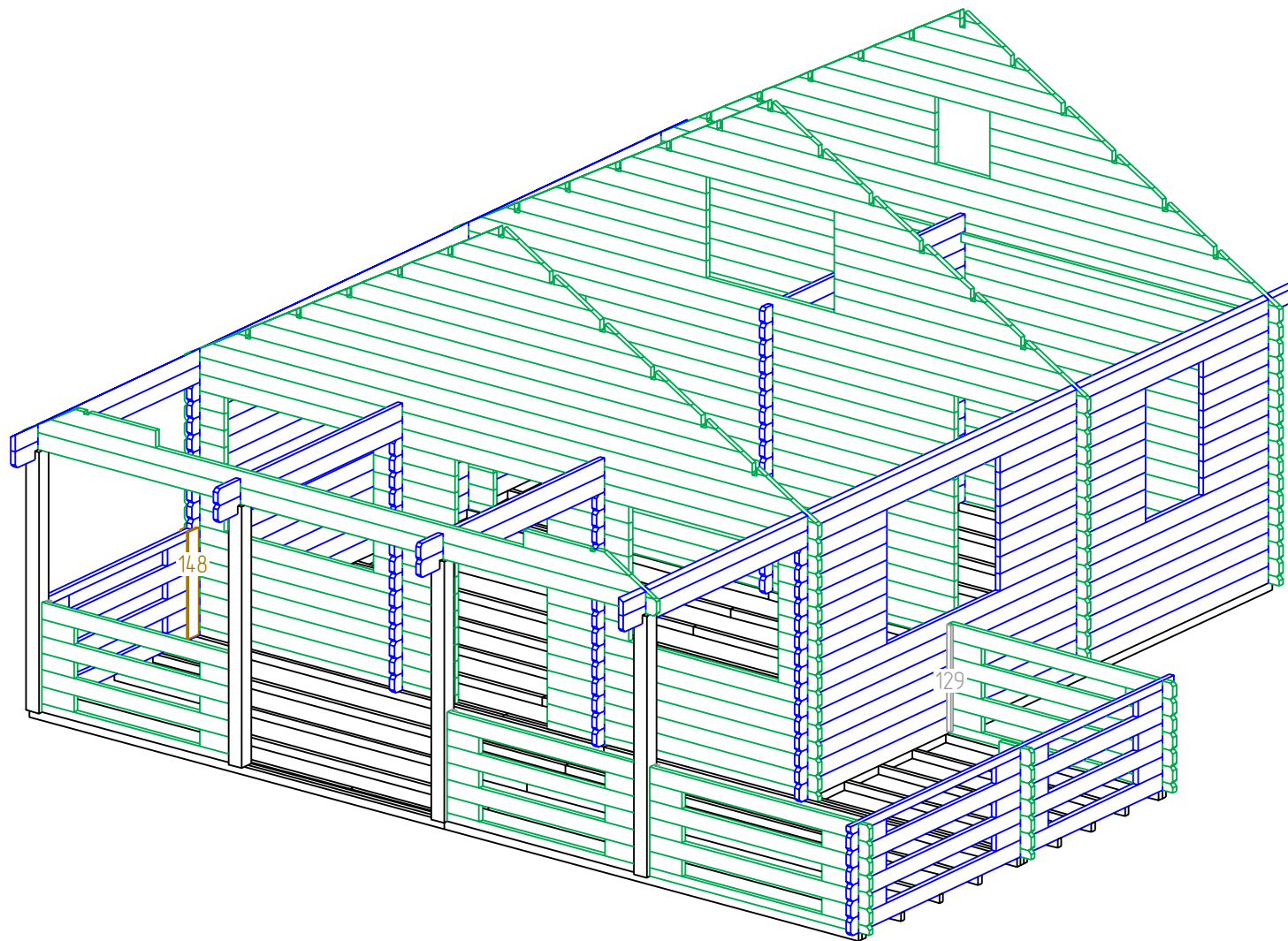

STAGE 2

Argus 44 6x6

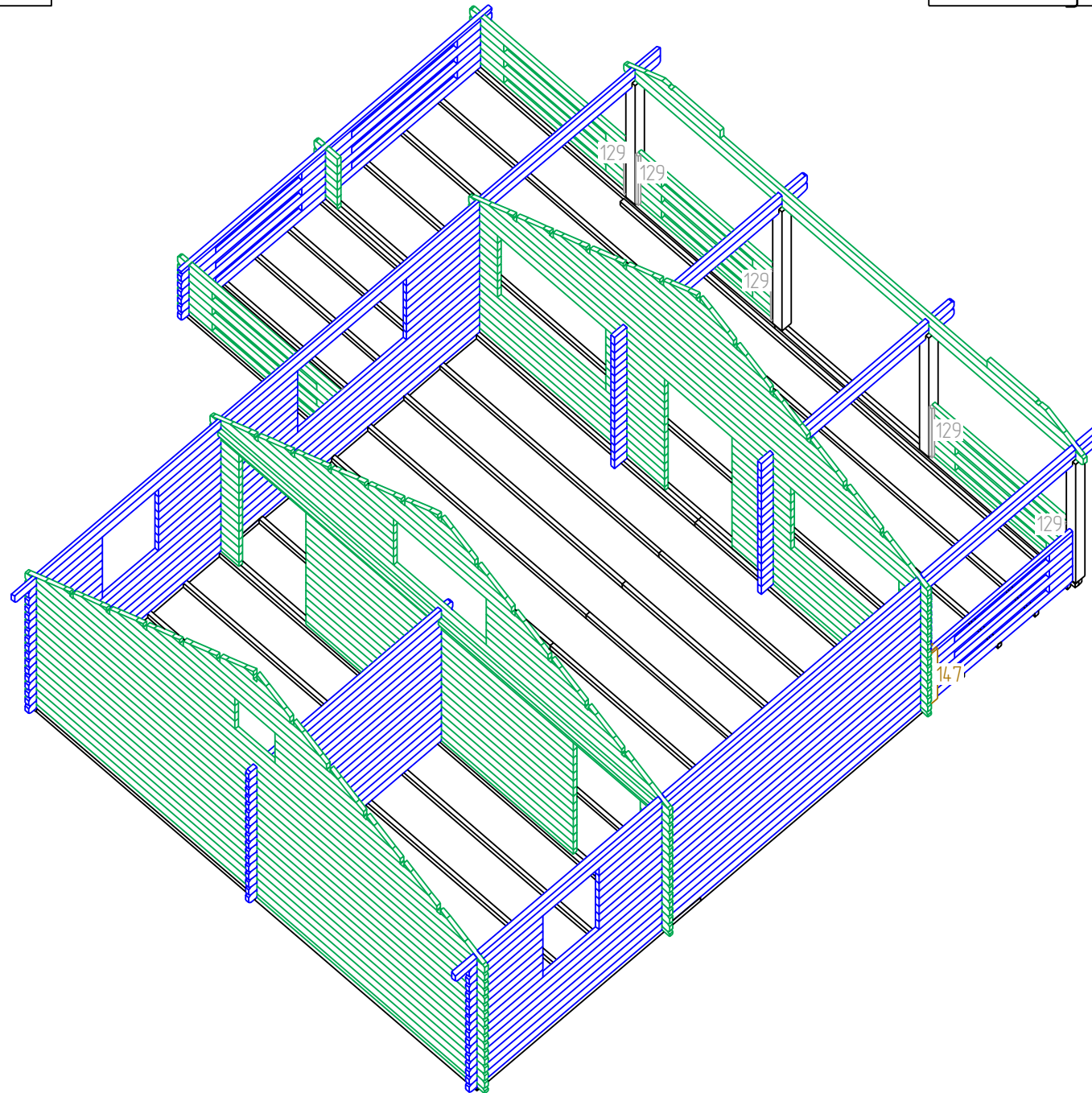

STAGE 3

Argus 44 6x6

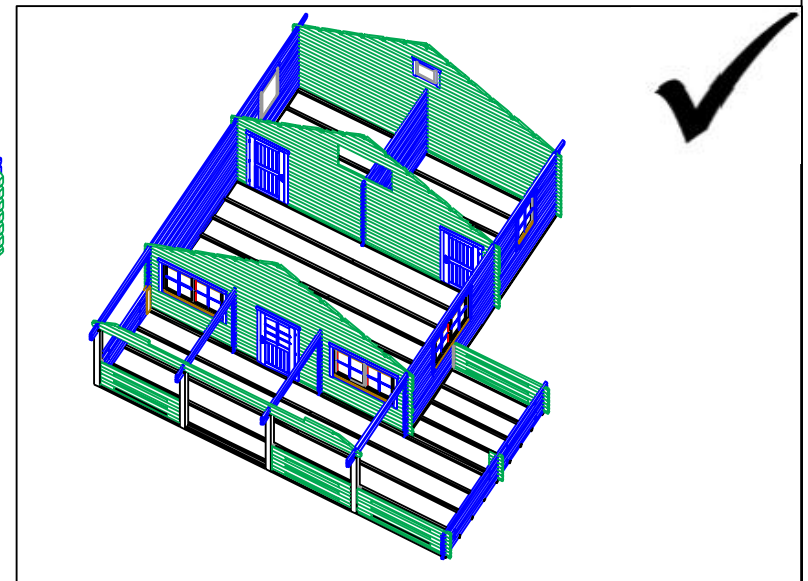
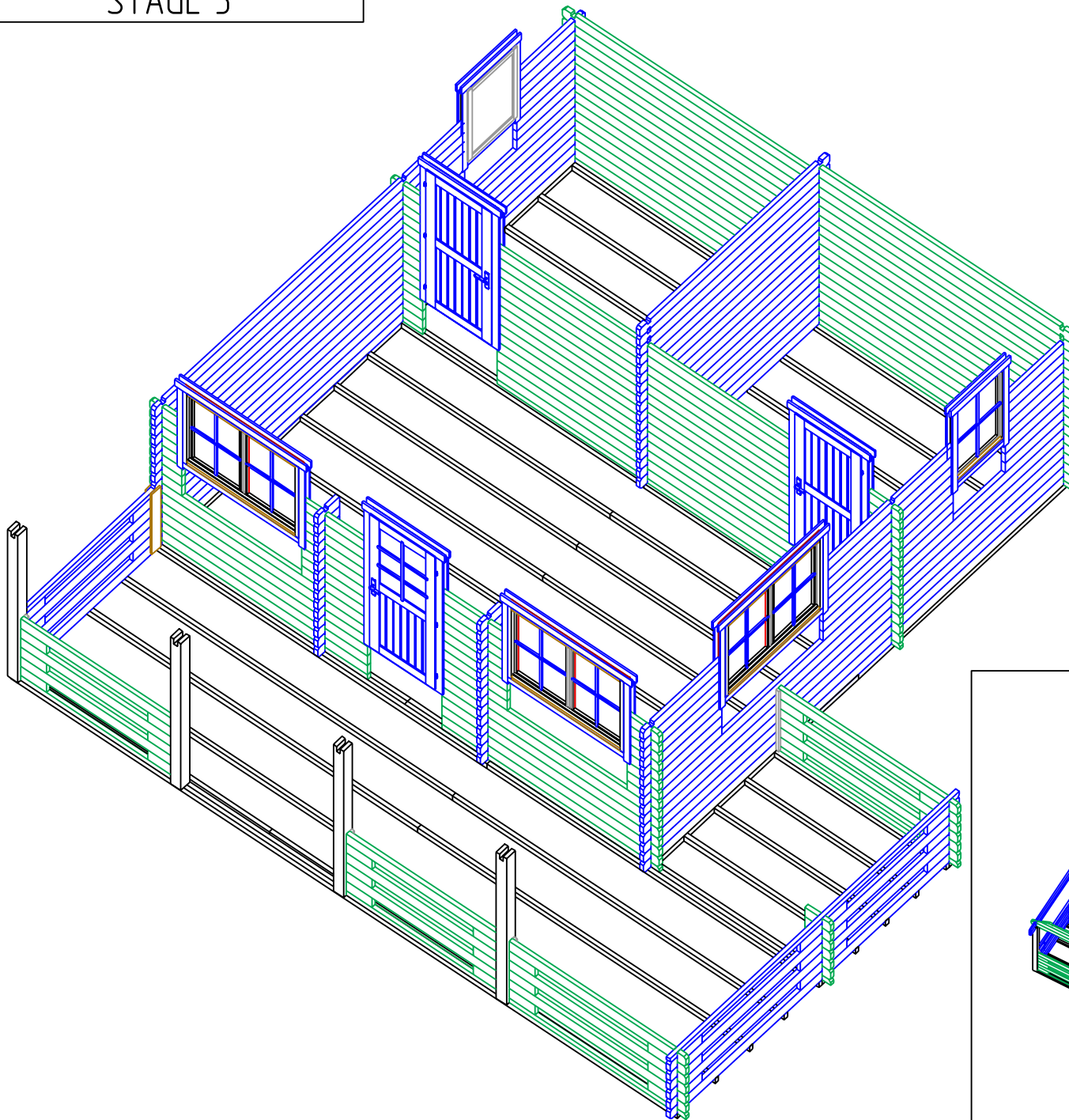

STAGE 4

Argus 44 6x6

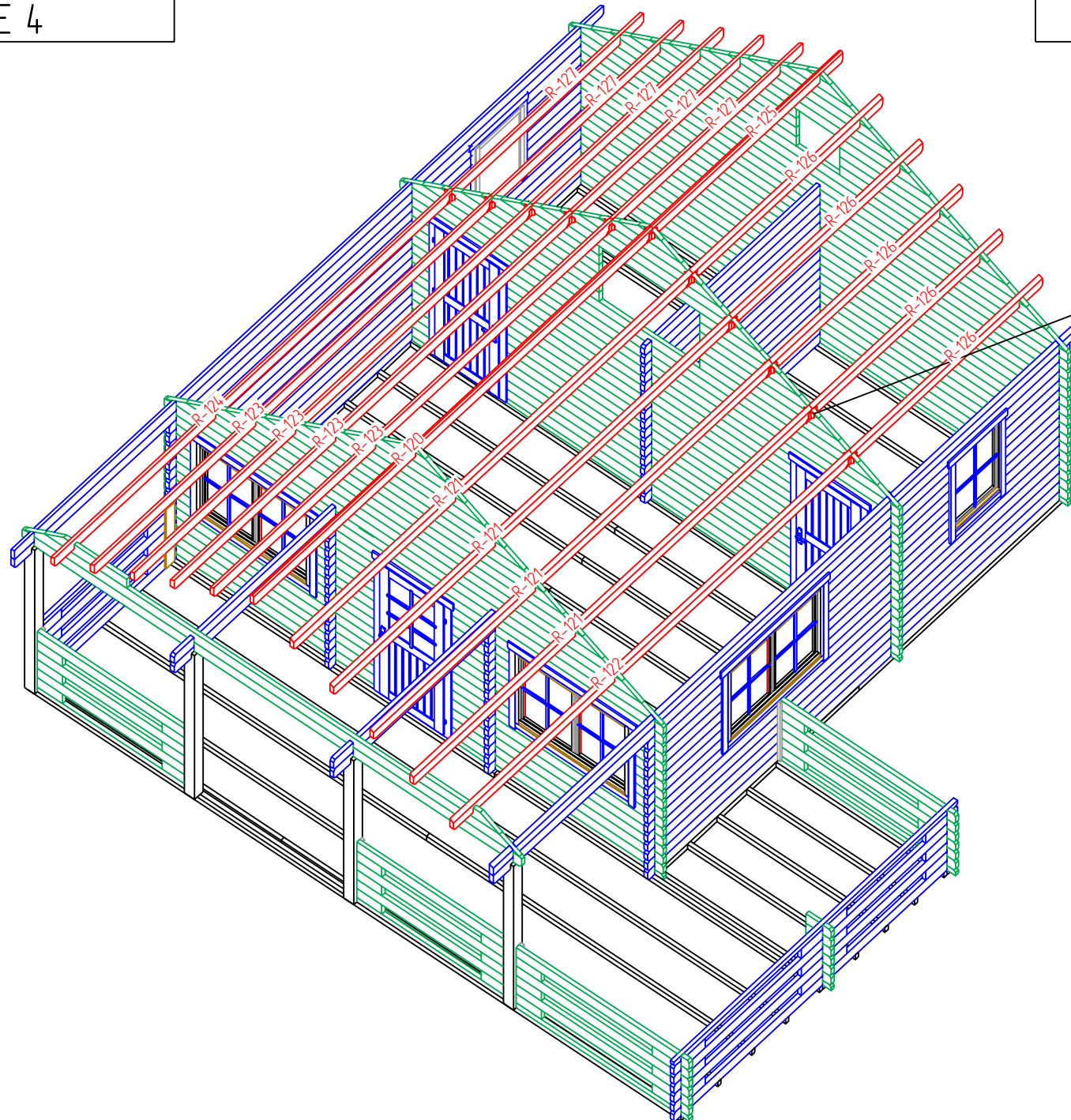

BS 45x96 - 22 psc

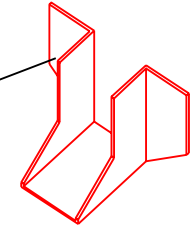

STAGE 5

Argus 44 6x6

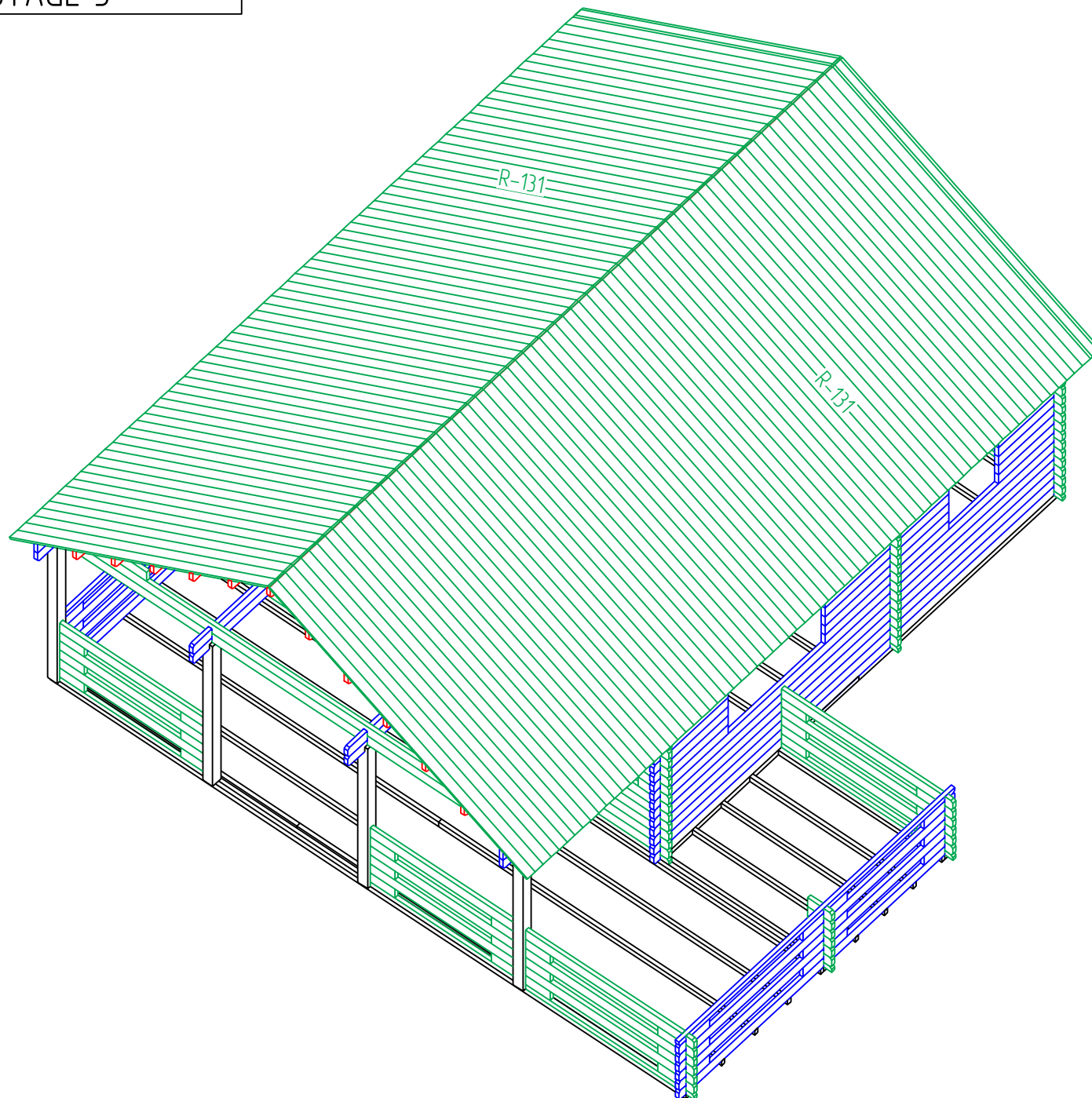

STAGE 6

Argus 44 6x6

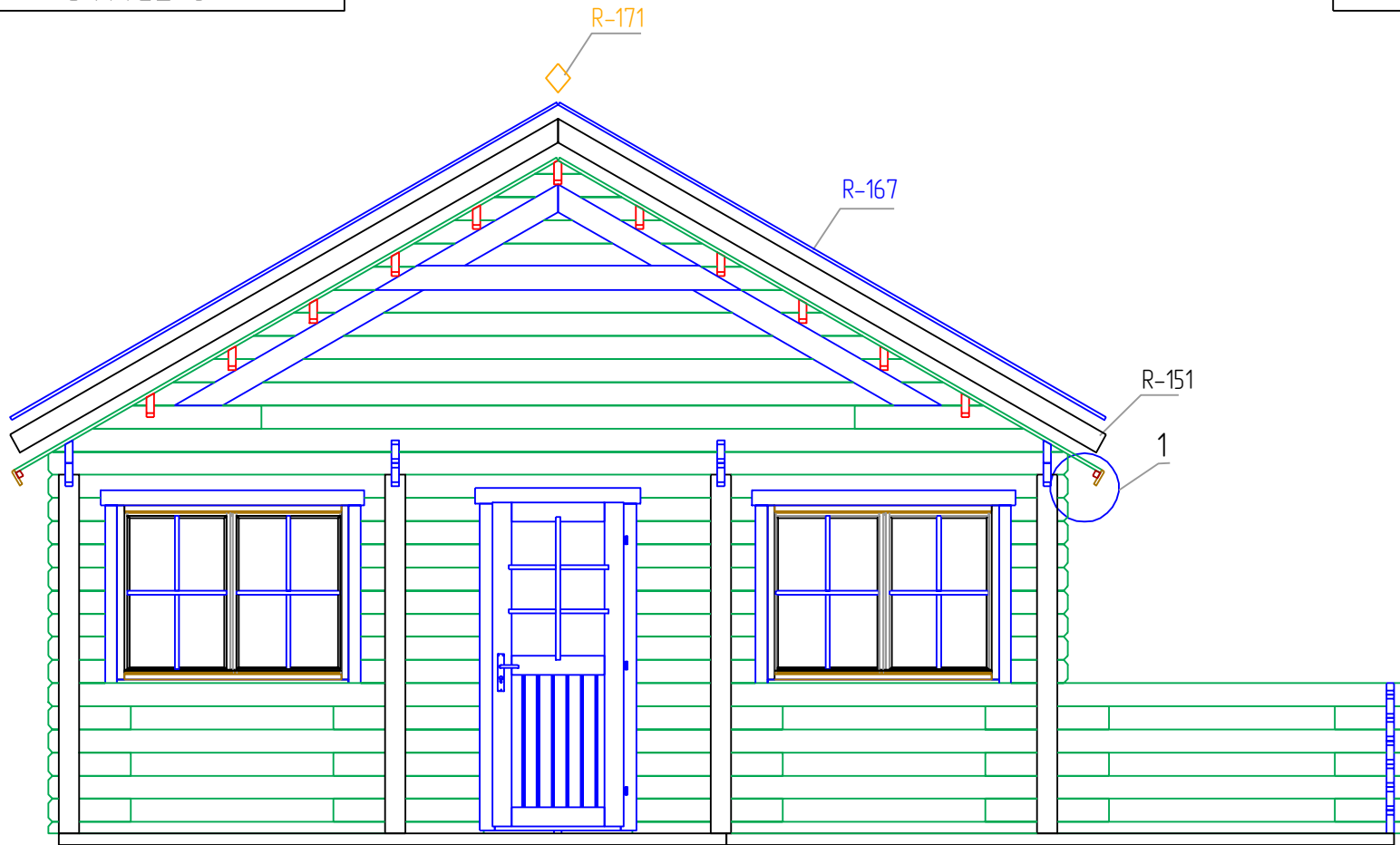

$\frac{1}{M 1:5}$

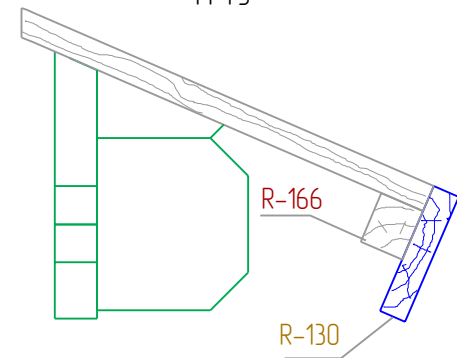

STAGE 6

Argus 44 6x6

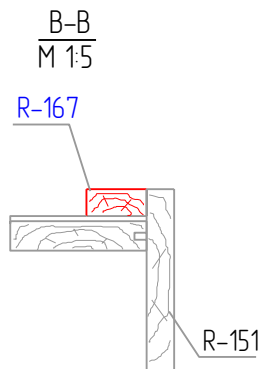

STAGE 7

Argus 44 6x6

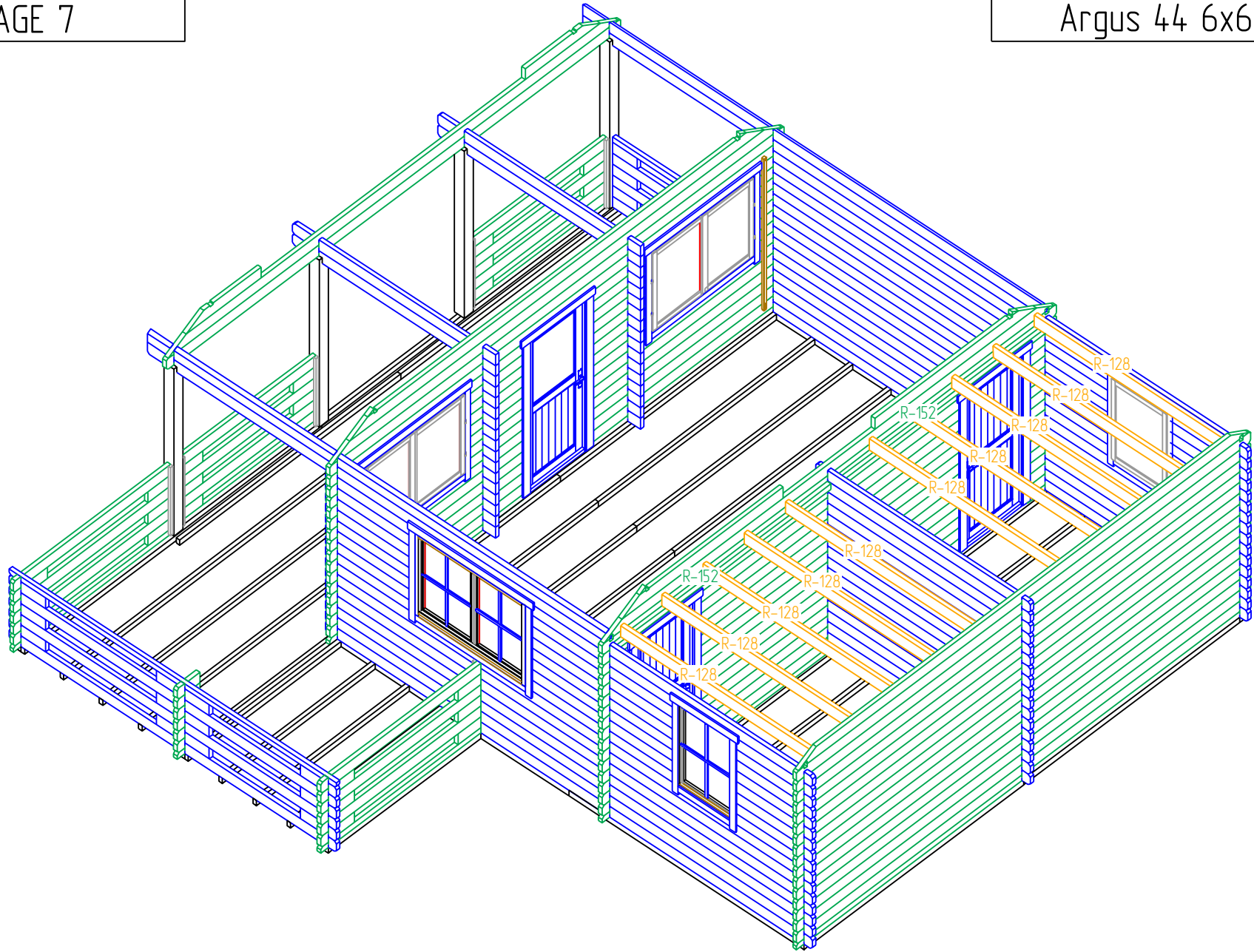

STAGE 7

Argus 44 6x6

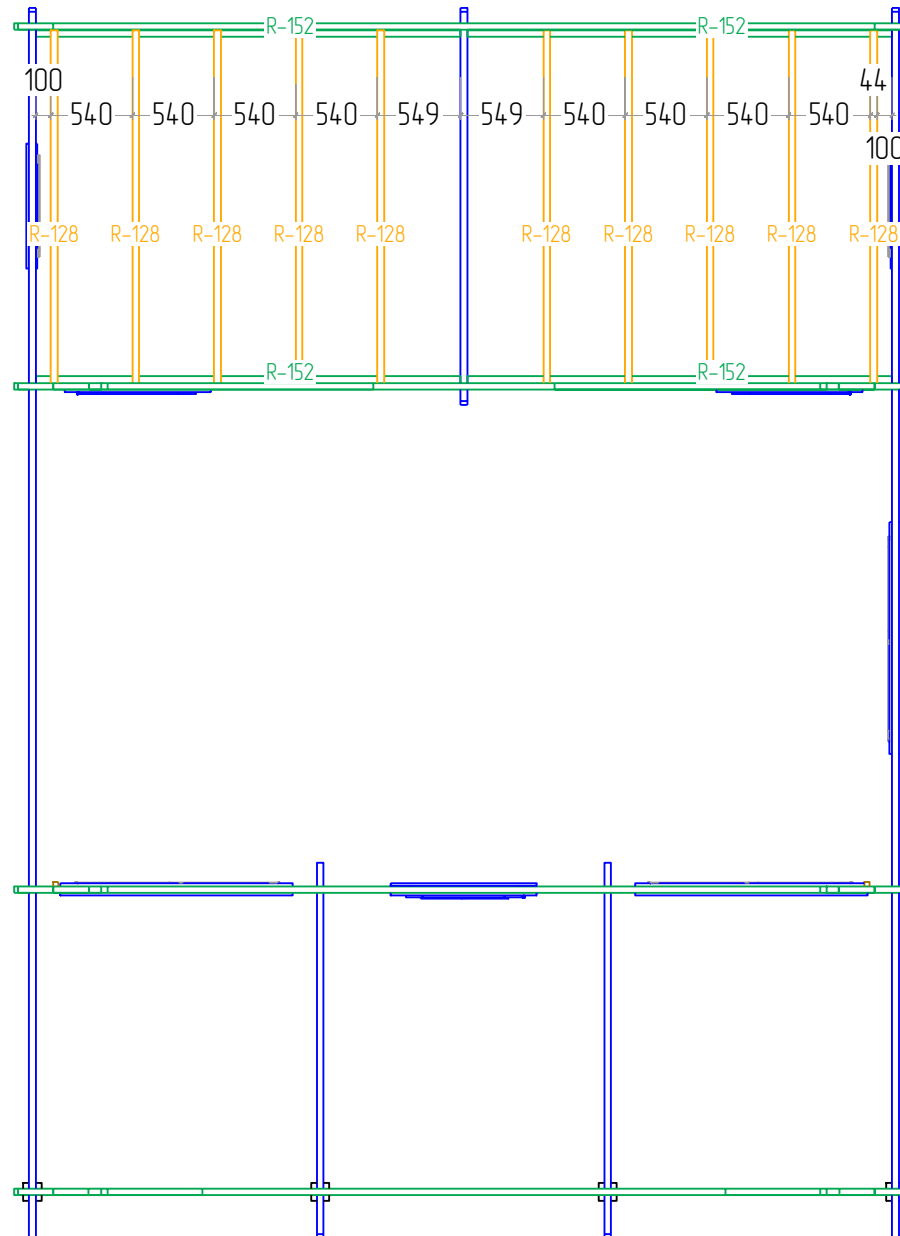

First floor

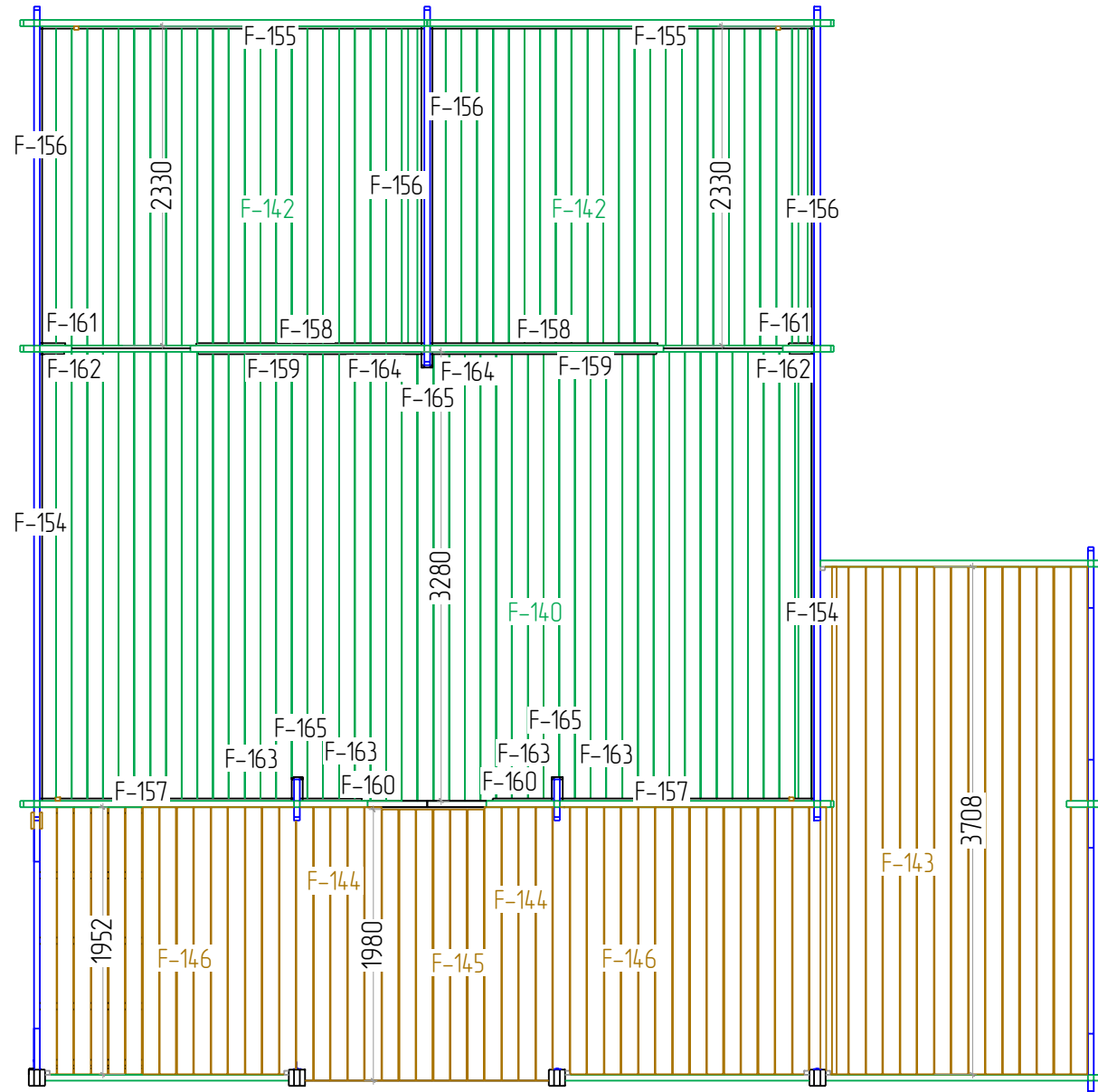

Second floor

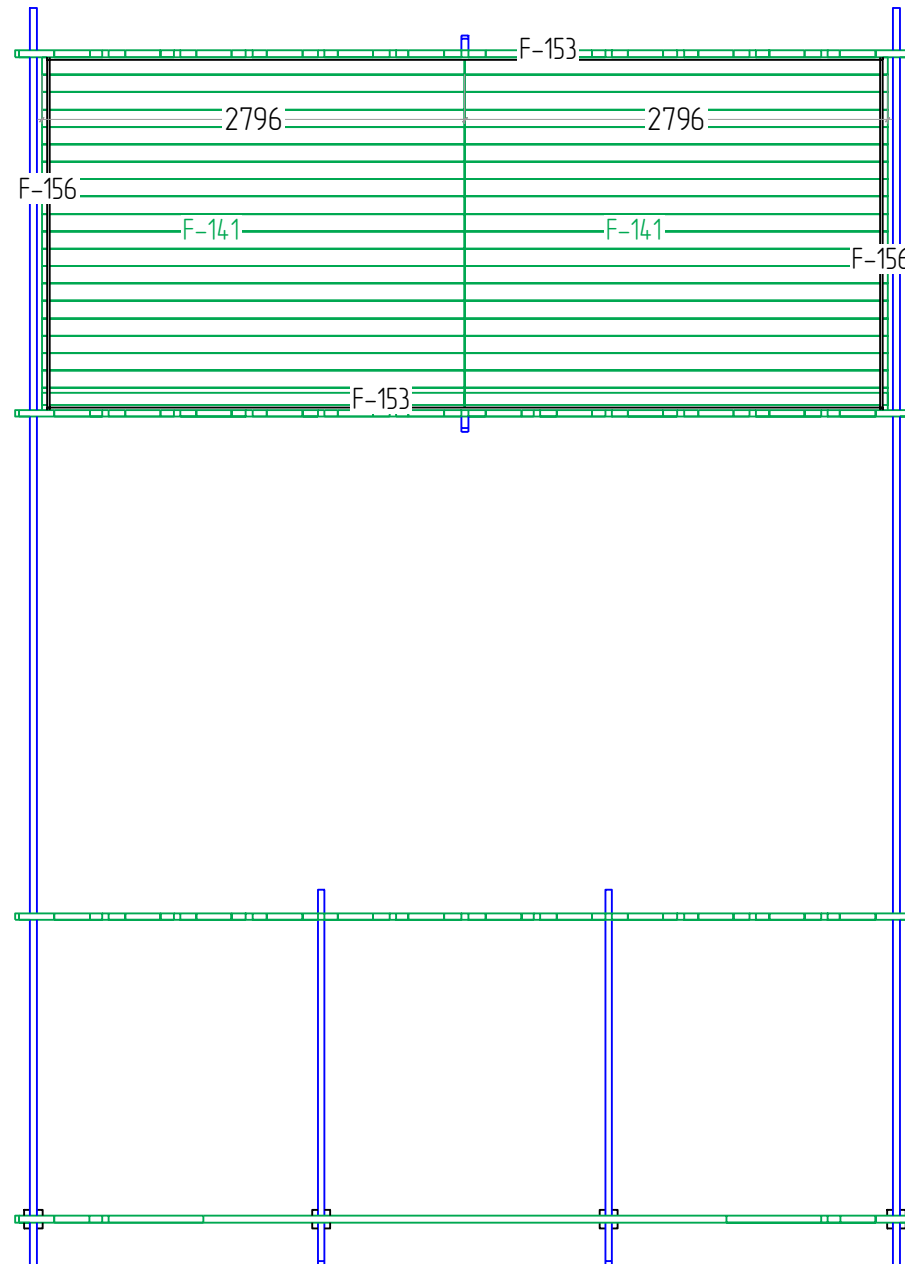

STAGE 9

Argus 44 6x6

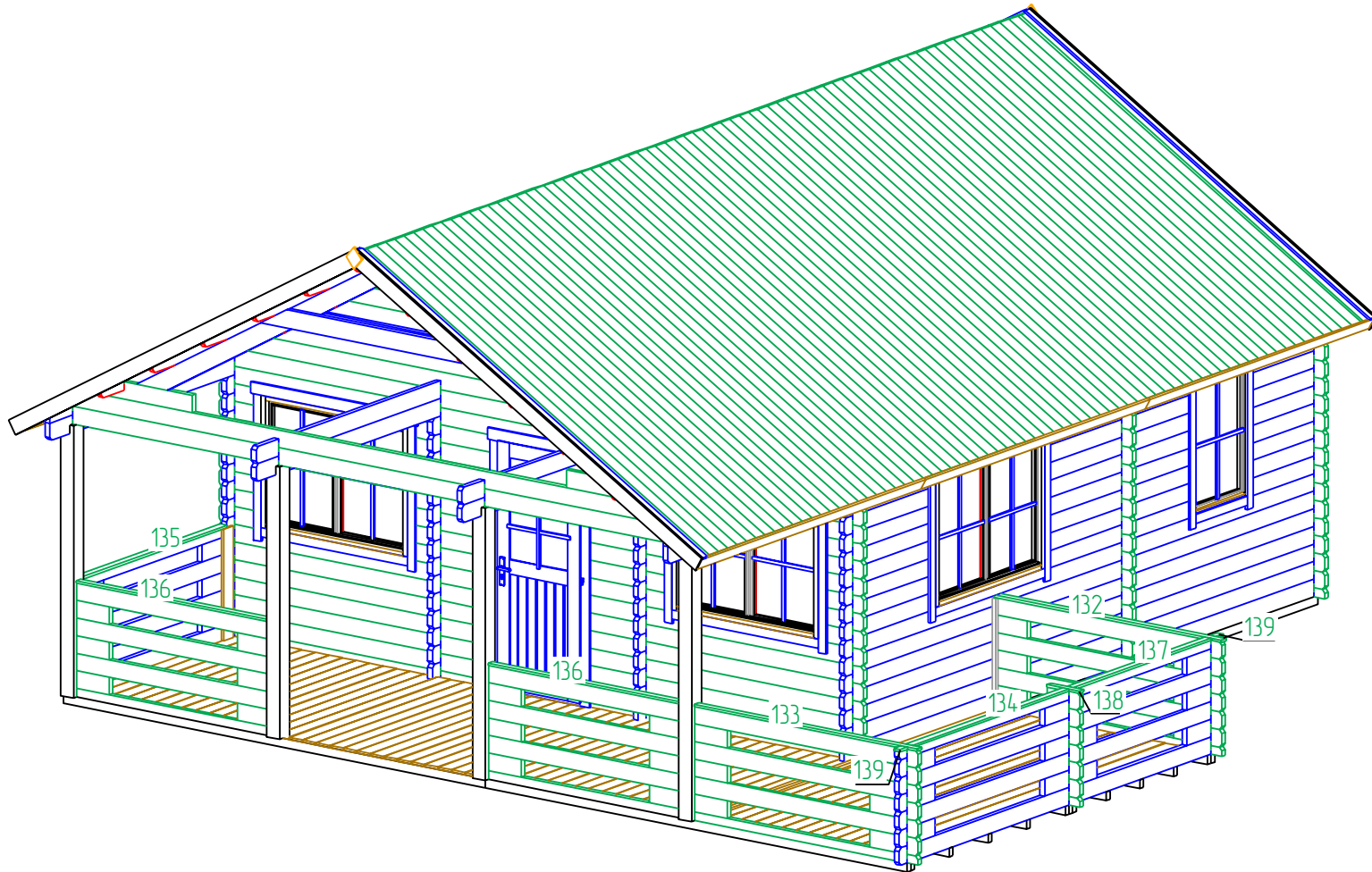

STAGE 10

Argus 44 6x6

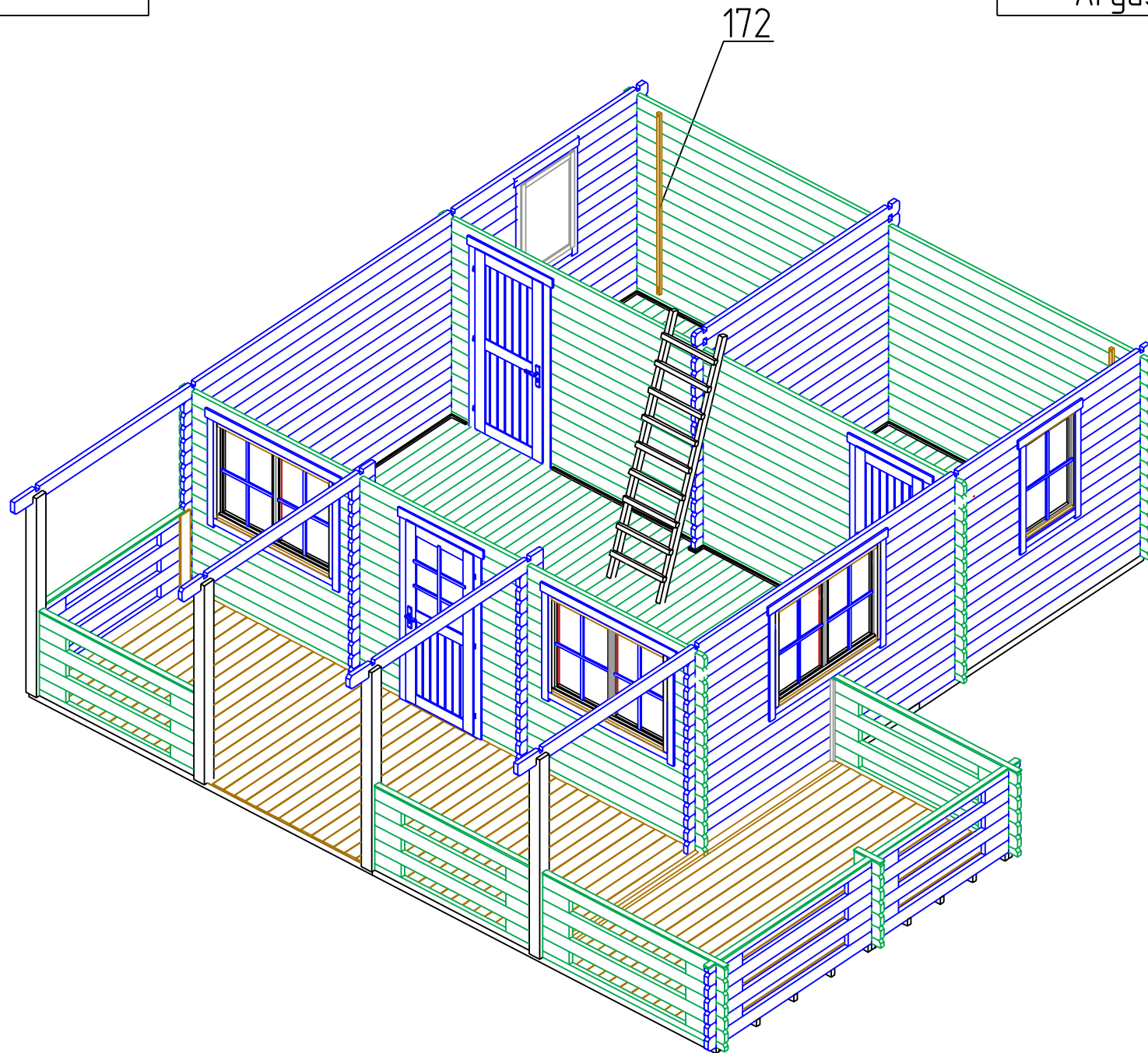

STAGE 1

F
NR: 114
PSC: 4
B/H: 44mm/68mm
L: 3894mm

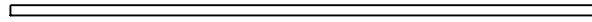

F
NR: 115
PSC: 8
B/H: 44mm/68mm
L: 3875mm

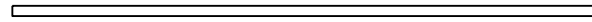

F
NR: 116
PSC: 2
B/H: 44mm/68mm
L: 2894mm

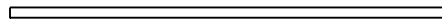

F
NR: 117
PSC: 4
B/H: 44mm/68mm
L: 2875mm

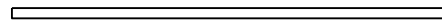

F
NR: 118
PSC: 32
B/H: 44mm/68mm
L: 2831mm

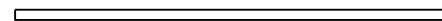

F
NR: 119
PSC: 7
B/H: 44mm/68mm
L: 2000mm



NR: 170
PSC: 4
B/H: 116mm/100mm
L: 2092mm

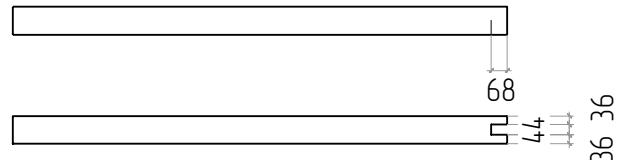

STAGE 2

W
NR: A 1
PSC: 2
B/H: 44mm/68mm
L: 2540mm



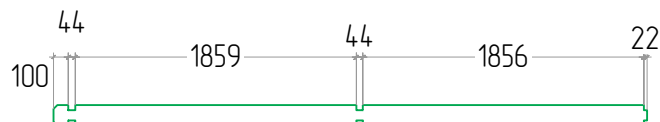

W
NR: A 9
PSC: 1
B/H: 44mm/135mm
L: 3925mm





W
NR: A 13
PSC: 12
B/H: 44mm/135mm
L: 2540mm

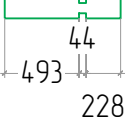
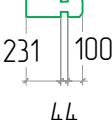
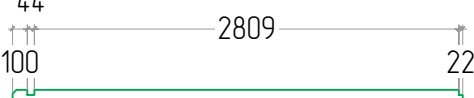
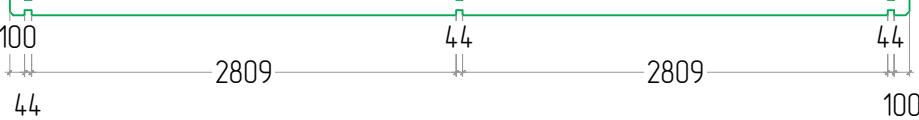

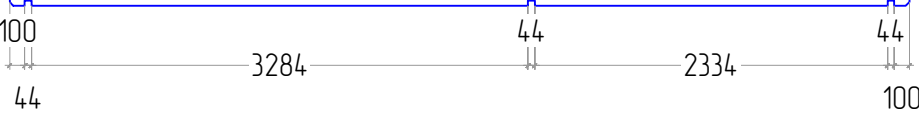
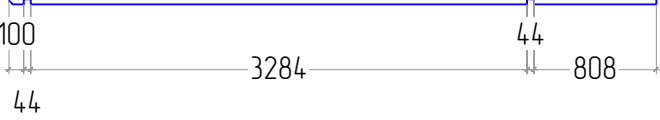
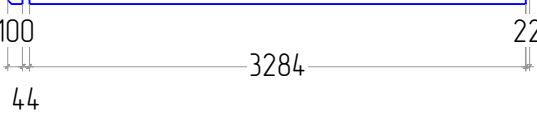
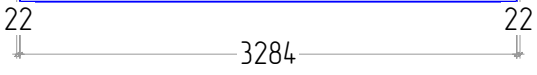
Argus 44 6x6

<p>W NR: A 15 PSC: 1 B/H: 44mm/135mm L: 2025mm</p>	
<p>W NR: A 19 PSC: 16 B/H: 44mm/135mm L: 765mm</p>	
<p>W NR: A 21 PSC: 16 B/H: 44mm/135mm L: 375mm</p>	
<p>W NR: B 22 PSC: 2 B/H: 44mm/68mm L: 2975mm</p>	
<p>W NR: B 24 PSC: 4 B/H: 44mm/135mm L: 5950mm</p>	
<p>W NR: B 29 PSC: 24 B/H: 44mm/135mm L: 2975mm</p>	
<p>W NR: C 39 PSC: 1 B/H: 44mm/66mm L: 1818mm</p>	
<p>W NR: C 40 PSC: 1 B/H: 44mm/135mm L: 5950mm</p>	
<p>W NR: C 41 PSC: 8 B/H: 44mm/135mm L: 4280mm</p>	
<p>W NR: C 42 PSC: 7 B/H: 44mm/135mm L: 3450mm</p>	
<p>W NR: C 43 PSC: 1 B/H: 44mm/135mm L: 3328mm</p>	

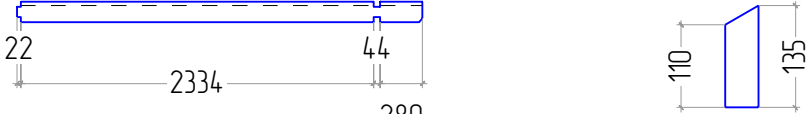
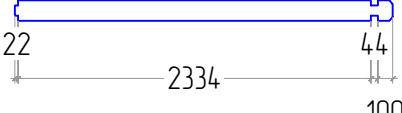
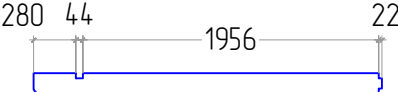
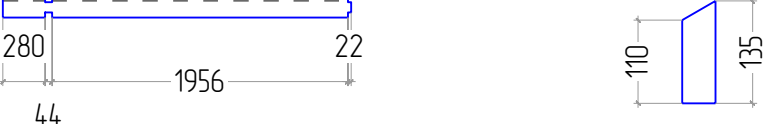
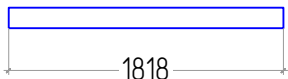
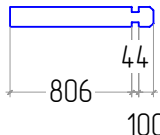

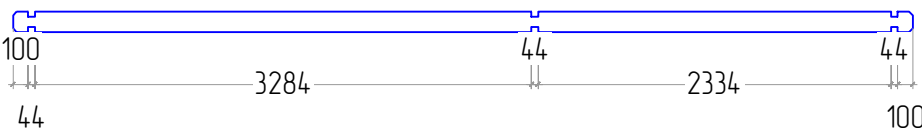
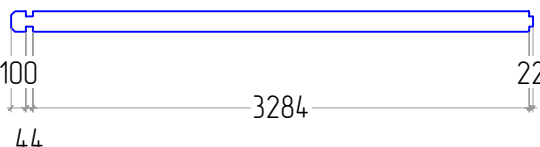
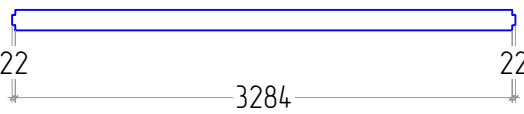

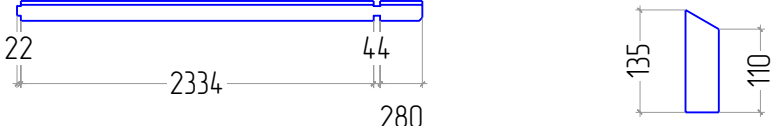
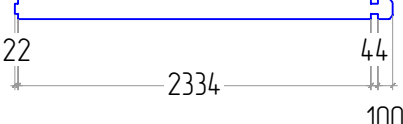
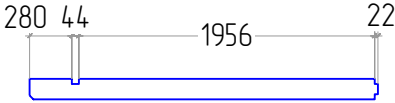
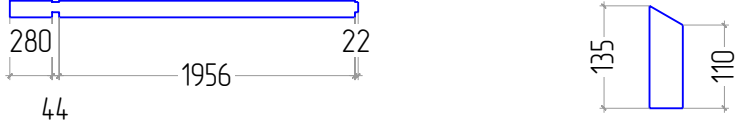
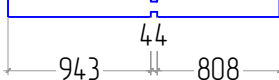
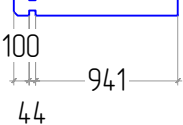
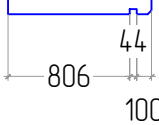
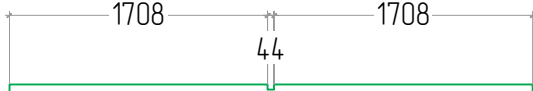
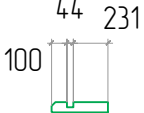
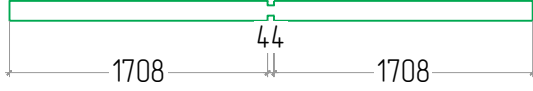

Argus 44 6x6

<p>W NR: C 44 PSC: 1 B/H: 44mm/135mm L: 3328mm</p>	
<p>W NR: C 45 PSC: 1 B/H: 44mm/135mm L: 2680mm</p>	
<p>W NR: C 46 PSC: 8 B/H: 44mm/135mm L: 2500mm</p>	
<p>W NR: C 47 PSC: 1 B/H: 44mm/135mm L: 2302mm</p>	
<p>W NR: C 48 PSC: 1 B/H: 44mm/135mm L: 2302mm</p>	
<p>W NR: C 49 PSC: 3 B/H: 44mm/135mm L: 1818mm</p>	
<p>W NR: C 50 PSC: 8 B/H: 44mm/135mm L: 950mm</p>	
<p>W NR: C 51 PSC: 6 B/H: 44mm/135mm L: 300mm</p>	
<p>W NR: D 52 PSC: 1 B/H: 44mm/135mm L: 5950mm</p>	
<p>W NR: D 53 PSC: 6 B/H: 44mm/135mm L: 3450mm</p>	
<p>W NR: D 54 PSC: 1 B/H: 44mm/135mm L: 3328mm</p>	

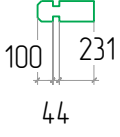
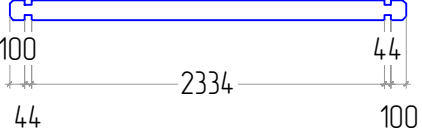
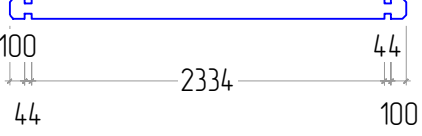
Argus 44 6x6

<p>W NR: D 55 PSC: 1 B/H: 44mm/135mm L: 3328mm</p>	
<p>W NR: D 56 PSC: 1 B/H: 44mm/135mm L: 2680mm</p>	
<p>W NR: D 57 PSC: 7 B/H: 44mm/135mm L: 2500mm</p>	
<p>W NR: D 58 PSC: 1 B/H: 44mm/135mm L: 2302mm</p>	
<p>W NR: D 59 PSC: 1 B/H: 44mm/135mm L: 2302mm</p>	
<p>W NR: D 60 PSC: 8 B/H: 44mm/135mm L: 1795mm</p>	
<p>W NR: D 61 PSC: 8 B/H: 44mm/135mm L: 1085mm</p>	
<p>W NR: D 62 PSC: 8 B/H: 44mm/135mm L: 950mm</p>	
<p>W NR: E 63 PSC: 1 B/H: 44mm/68mm L: 3460mm</p>	
<p>W NR: E 64 PSC: 2 B/H: 44mm/68mm L: 375mm</p>	
<p>W NR: E 67 PSC: 14 B/H: 44mm/135mm L: 3460mm</p>	



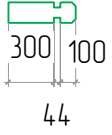

Argus 44 6x6

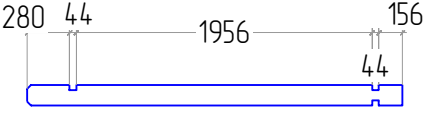
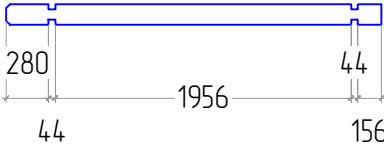
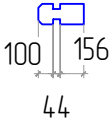
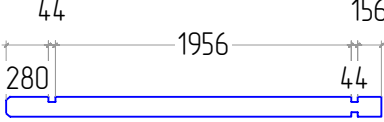
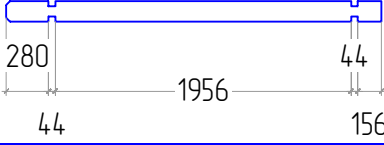
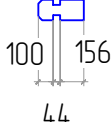
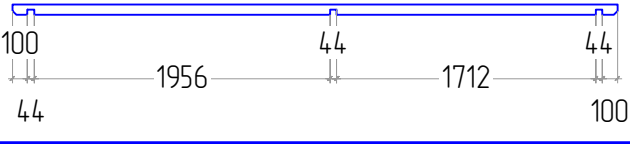
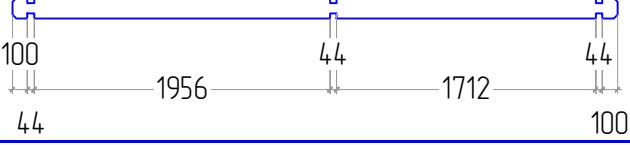
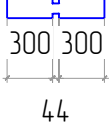
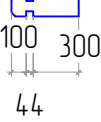
<p>W NR: E 69 PSC: 2 B/H: 44mm/135mm L: 2975mm</p>	
<p>W NR: E 81 PSC: 28 B/H: 44mm/135mm L: 375mm</p>	
<p>W NR: F 82 PSC: 1 B/H: 44mm/134mm L: 2622mm</p>	
<p>W NR: F 83 PSC: 16 B/H: 44mm/135mm L: 2622mm</p>	
<p>W NR: G 84 PSC: 1 B/H: 44mm/68mm L: 2062mm</p>	 <p>- профиль сверху (шп)</p>
<p>W NR: G 85 PSC: 2 B/H: 44mm/68mm L: 1783mm</p>	 <p>- профиль сверху (шп)</p>
<p>W NR: G 86 PSC: 1 B/H: 44mm/134mm L: 2062mm</p>	
<p>W NR: G 87 PSC: 2 B/H: 44mm/134mm L: 1783mm</p>	
<p>W NR: G 91 PSC: 2 B/H: 44mm/135mm L: 2062mm</p>	
<p>W NR: G 93 PSC: 4 B/H: 44mm/135mm L: 1783mm</p>	
<p>W NR: G 94 PSC: 3 B/H: 44mm/135mm L: 444mm</p>	



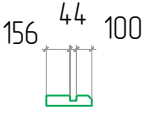
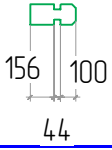
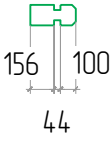

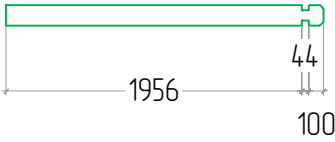
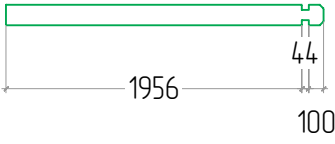
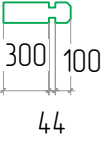
Argus 44 6x6

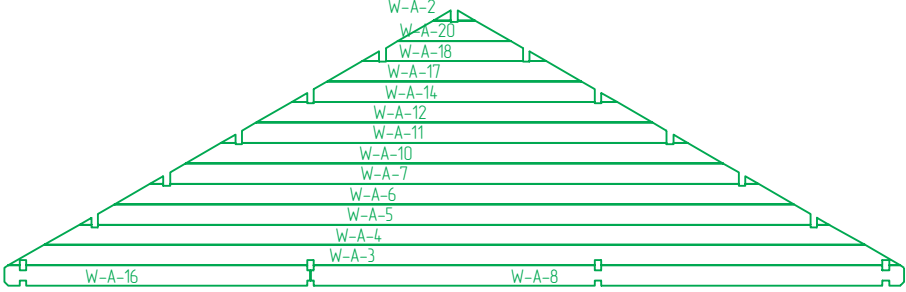
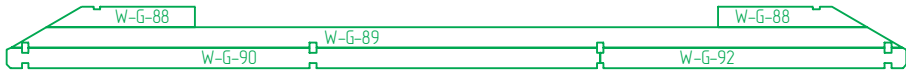
<p>W NR: G 95 PSC: 15 B/H: 44mm/135mm L: 300mm</p>	
<p>W NR: H 96 PSC: 1 B/H: 44mm/135mm L: 2480mm</p>	
<p>W NR: H 97 PSC: 1 B/H: 44mm/135mm L: 2480mm</p>	
<p>W NR: H 98 PSC: 15 B/H: 44mm/135mm L: 300mm</p>	
<p>W NR: I 99 PSC: 1 B/H: 44mm/135mm L: 2480mm</p>	
<p>W NR: I 100 PSC: 1 B/H: 44mm/135mm L: 2480mm</p>	
<p>W NR: I 101 PSC: 15 B/H: 44mm/135mm L: 300mm</p>	
<p>W NR: J 102 PSC: 1 B/H: 44mm/66mm L: 4000mm</p>	
<p>W NR: J 103 PSC: 3 B/H: 44mm/135mm L: 4000mm</p>	
<p>W NR: J 104 PSC: 3 B/H: 44mm/135mm L: 644mm</p>	
<p>W NR: J 105 PSC: 6 B/H: 44mm/135mm L: 444mm</p>	

Argus 44 6x6

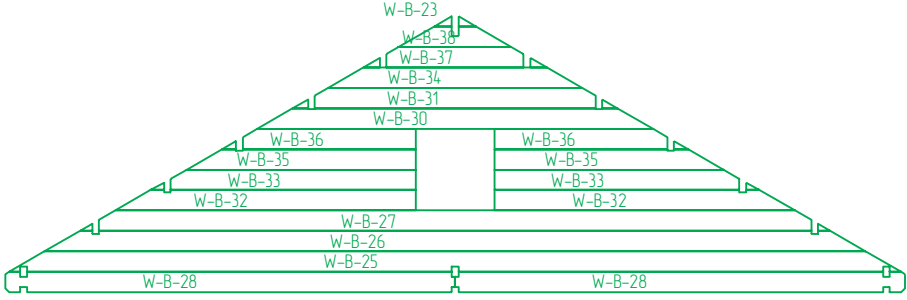
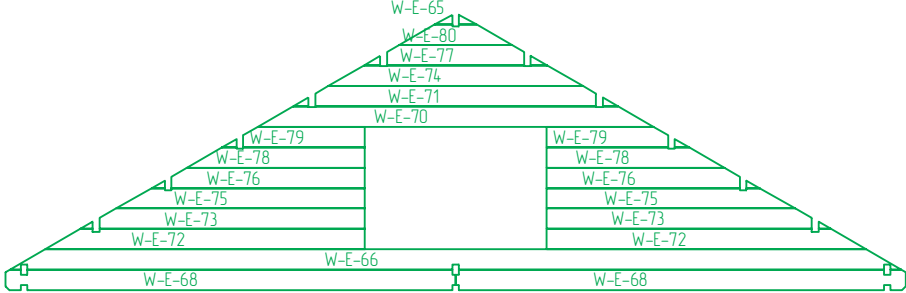
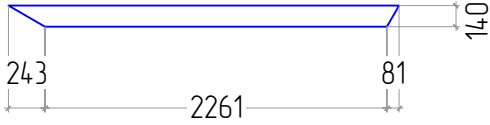
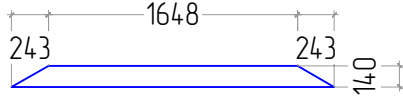
<p>W NR: K 106 PSC: 1 B/H: 44mm/68mm L: 300mm</p>	
<p>W NR: K 107 PSC: 1 B/H: 44mm/134mm L: 300mm</p>	
<p>W NR: K 108 PSC: 5 B/H: 44mm/135mm L: 300mm</p>	
<p>W NR: L 109 PSC: 1 B/H: 44mm/68mm L: 2100mm</p>	
<p>W NR: L 110 PSC: 1 B/H: 44mm/134mm L: 2100mm</p>	
<p>W NR: L 111 PSC: 2 B/H: 44mm/135mm L: 2100mm</p>	
<p>W NR: L 112 PSC: 3 B/H: 44mm/135mm L: 444mm</p>	
<p>W NR: L 113 PSC: 3 B/H: 44mm/135mm L: 300mm</p>	
<p>W NR: A PSC: 1</p>	
<p>W NR: G PSC: 1</p>	

Argus 44 6x6

<p>W NR: B PSC: 1</p>	
<p>W NR: E PSC: 1</p>	
<p>R NR: 168 PSC: 2 B/H: 44mm/140mm L: 2585mm</p>	
<p>R NR: 169 PSC: 2 B/H: 44mm/140mm L: 2133mm</p>	
<p>NR: 129 PSC: 6 B/H: 28mm/34mm L: 857mm</p>	
<p>NR: 147 PSC: 1 B/H: 120mm/18mm L: 876mm</p>	
<p>NR: 148 PSC: 1 B/H: 120mm/18mm L: 857mm</p>	
<h2>STAGE 3</h2>	
<p>Door PSC: 1 B/H: 870mm/1958mm</p>	<p>частично-остекленная</p>
<p>Door PSC: 2 B/H: 870mm/1958mm</p>	<p>злухая</p>

Window PSC: 3 B/H: 1400mm/1080mm	
Window PSC: 2 B/H: 720mm/1080mm	
Window PSC: 1 B/H: 520mm/540mm	

STAGE 4

R NR: 120 PSC: 1 B/H: 44mm/140mm L: 5630mm	
R NR: 121 PSC: 4 B/H: 44mm/140mm L: 5630mm	
R NR: 122 PSC: 1 B/H: 44mm/140mm L: 5630mm	
R NR: 123 PSC: 4 B/H: 44mm/140mm L: 5630mm	
R NR: 124 PSC: 1 B/H: 44mm/140mm L: 5630mm	
R NR: 125 PSC: 1 B/H: 44mm/140mm L: 2680mm	
R NR: 126 PSC: 5 B/H: 44mm/140mm L: 2680mm	
R NR: 127 PSC: 5 B/H: 44mm/140mm L: 2680mm	

STAGE 5

R
 NR: 131
 PSC: **147**
 B/H: 115mm/20mm
 L: 3650mm



STAGE 6

R
 NR: 130
 PSC: **6**
 B/H: 18mm/95mm
 L: 2770mm



R
 NR: 151
 PSC: **4**
 B/H: 18mm/120mm
 L: 3692mm

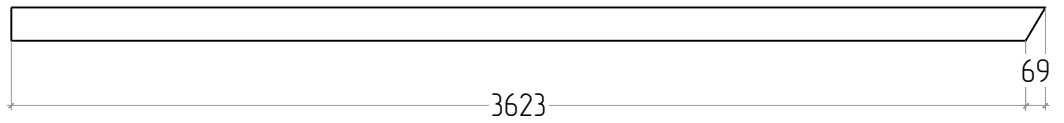

R
 NR: 166
 PSC: **6**
 B/H: 28mm/34mm
 L: 2770mm



R
 NR: 167
 PSC: **4**
 B/H: 58mm/18mm
 L: 3680mm



R
 NR: 171
 PSC: **2**
 B/H: 120mm/18mm
 L: 120mm



STAGE 7

R
 NR: 128
 PSC: **10**
 B/H: 44mm/140mm
 L: 2333mm



R
 NR: 152
 PSC: **4**
 B/H: 44mm/68mm
 L: 2807mm











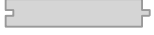

STAGE 8







F
 NR: 140
 PSC: **51**
 B/H: 115mm/20mm
 L: 3280mm



Argus 44 6x6

<p>F NR: 141 PSC: 42 B/H: 115mm/20mm L: 2796mm</p>	
<p>F NR: 142 PSC: 51 B/H: 115mm/20mm L: 2330mm</p>	
<p>F NR: 143 PSC: 17 B/H: 120mm/18mm L: 3708mm</p>	
<p>F NR: 144 PSC: 9 B/H: 120mm/18mm L: 1998mm</p>	
<p>F NR: 145 PSC: 6 B/H: 120mm/18mm L: 1980mm</p>	
<p>F NR: 146 PSC: 31 B/H: 120mm/18mm L: 1952mm</p>	
<p>F NR: 153 PSC: 2 B/H: 18mm/20mm L: 5527mm</p>	
<p>F NR: 154 PSC: 2 B/H: 18mm/20mm L: 3284mm</p>	
<p>F NR: 155 PSC: 2 B/H: 18mm/20mm L: 2809mm</p>	
<p>F NR: 156 PSC: 6 B/H: 18mm/20mm L: 2334mm</p>	
<p>F NR: 157 PSC: 2 B/H: 18mm/20mm L: 1859mm</p>	

F NR: 158 PSC: 2 B/H: 18mm/20mm L: 1665mm	<input type="checkbox"/>
F NR: 159 PSC: 2 B/H: 18mm/20mm L: 1655mm	<input type="checkbox"/>
F NR: 160 PSC: 2 B/H: 18mm/20mm L: 450mm	<input type="checkbox"/>
F NR: 161 PSC: 2 B/H: 18mm/20mm L: 188mm	<input type="checkbox"/>
F NR: 162 PSC: 2 B/H: 18mm/20mm L: 178mm	<input type="checkbox"/>
F NR: 163 PSC: 4 B/H: 18mm/20mm L: 174mm	<input type="checkbox"/>
F NR: 164 PSC: 2 B/H: 18mm/20mm L: 118mm	<input type="checkbox"/>
F NR: 165 PSC: 3 B/H: 18mm/20mm L: 80mm	<input type="checkbox"/>
STAGE 9	
NR: 132 PSC: 1 B/H: 18mm/58mm L: 2100mm	<input type="checkbox"/>
NR: 133 PSC: 1 B/H: 18mm/58mm L: 2062mm	<input type="checkbox"/>

NR: 134 PSC: 1 B/H: 18mm/58mm L: 1942mm	
NR: 135 PSC: 1 B/H: 18mm/58mm L: 1818mm	
NR: 136 PSC: 2 B/H: 18mm/58mm L: 1783mm	
NR: 137 PSC: 1 B/H: 18mm/58mm L: 1698mm	
NR: 138 PSC: 1 B/H: 18mm/58mm L: 300mm	
NR: 139 PSC: 2 B/H: 18mm/58mm L: 93mm	
STAGE 10	
NR: 172 PSC: 4 B/H: 28mm/34mm L: 1900mm	
PSC: 1	